

BMW 6 Series
Gran Coupé
Coupé
Convertible

www.bmw.com



Sheer
Driving Pleasure



THE BMW 6 SERIES. GRAN COUPÉ, COUPÉ AND CONVERTIBLE.

BMW EFFICIENT DYNAMICS.
LESS EMISSIONS. MORE DRIVING PLEASURE.

**THE NEXT
100 YEARS**





In 2016 the BMW brand will be celebrating its 100th anniversary. Find out more at www.next100.bmw

WANT TO DISCOVER MORE?

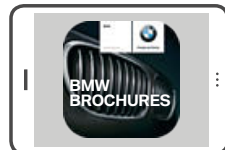

Discover the BMW 6 Series Gran Coupé, the BMW 6 Series Coupé and the BMW 6 Series Convertible in digital: simply download the interactive BMW brochure app for your device and select the model of your choice.

Internet use, depending on your mobile contract, may incur costs.

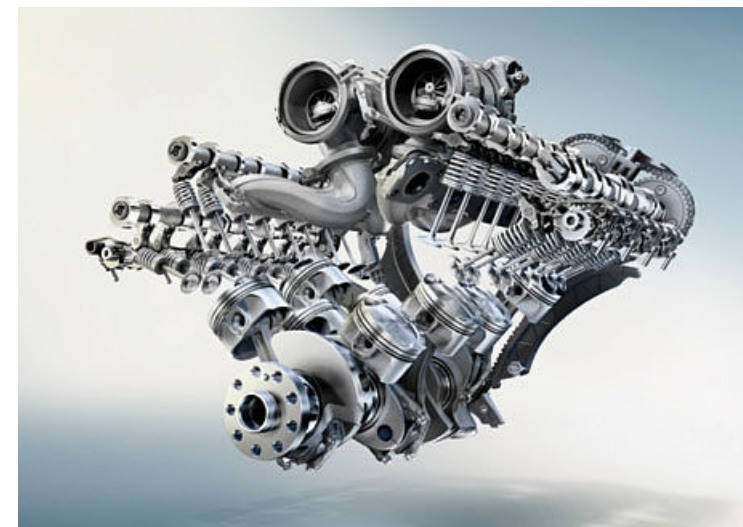

NEW DIMENSIONS OF DRIVING PLEASURE.

THE MODELS SHOWN.

- 04 BMW 6 SERIES GRAN COUPÉ WITH BMW INDIVIDUAL:** BMW TwinPower Turbo 8-cylinder petrol engine, 330 kW (450 hp), 20" BMW Individual light alloy wheels V-spoke 374 I, forged, with mixed tyres, BMW Individual Frozen Brilliant White metallic exterior colour, seats in Amaro Brown BMW Individual full fine-grain Merino leather, BMW Individual fine-wood interior trim Ash Grain White.

inspired by **BMW Individual**

- BMW 6 SERIES COUPÉ WITH M SPORT PACKAGE:** BMW TwinPower Turbo 8-cylinder petrol engine, 330 kW (450 hp), 20" M light alloy wheels Double-spoke 373 M with mixed tyres, Mediterranean Blue metallic exterior colour, seats in Bicolour Ivory White/Black exclusive Nappa leather, Aluminium Hexagon interior trim.

powered by

BMW 6 SERIES CONVERTIBLE WITH DESIGN PURE EXPERIENCE:

- BMW TwinPower Turbo 8-cylinder petrol engine, 330 kW (450 hp), 20" light alloy wheels Multi-spoke 616 with mixed, runflat tyres, Melbourne Red metallic exterior colour, seats in Bicolour Cognac/Black exclusive Nappa leather, Fineline Brown fine-wood interior trim.

INNOVATION AND TECHNOLOGY.

- 30 BMW TWIN POWER TURBO ENGINES:** At the heart of BMW EfficientDynamics.
- 32 BMW EFFICIENT DYNAMICS:** The joys of reducing consumption.
- 34 BMW CONNECTED DRIVE:** Services & Apps and driver assistance.
- 36 CHASSIS:** Innovative systems for more driving pleasure.
- 38 SAFETY:** Technology at the highest level.

INDIVIDUALITY AND VERSATILITY.

- 42 EQUIPMENT:** BMW Design Pure Excellence, BMW Design Pure Experience, M Sport package and BMW Individual, equipment highlights, wheels and tyres and Original BMW Accessories.
- 60 COLOURS:** A world of colour for the exterior and interior.
- 64 TECHNICAL DATA:** Weight, engine, transmission, performance, fuel consumption, wheels and dimensions.
- 66 BMW SERVICE:** BMW Service, BMW Financial Services and BMW Experience.

Further information on fuel consumption and CO₂ emissions can be found on pages 64/65 or consult your BMW partner.

IN THE BEST COMPANY.



It's rare to encounter a vehicle that goes so far beyond one's expectations. What's more, with the BMW 6 Series, the experience is threefold – with the Gran Coupé, Coupé and Convertible each setting the standards when it comes to luxury, sportiness and elegance in their own special way.

MAKES EVERY ROAD A RED CARPET.



One thing is certain: this vehicle's appearance captures the attention. The elegantly modelled rear profile of the BMW 6 Series Gran Coupé and the sleek lines of its flanks make it totally clear – luxurious design and leading-edge performance make for an outstanding partnership.

LUXURY TAKES ON A NEW FORM.





Rediscover luxury: perfectly poised on 20" BMW Individual light alloy wheels, the BMW 6 Series Gran Coupé is evidently on top of things. The same is true when it's out on the road, where the day-to-day dynamic superiority cannot be doubted – and the next day cannot come soon enough.

PERFORMANCE REFINED.





FEEL PERFECTION.

Take your seat. Look around. Experience for yourself how everything in the interior of the BMW 6 Series Gran Coupé combines absolute luxury with exceptional comfort. The high-quality, meticulously crafted materials and the flawless design surpass the most exacting expectations – and, thanks to BMW Individual, your personal wishes are transformed into road-going reality.

inspired by **BMW Individual**



TWO ROUTES. ONE GOAL.





WHEN LOUD IS GOOD.

Power – a message that comes through loud and clear when the 650i BMW TwinPower Turbo 8-cylinder petrol engine makes the air vibrate. The sound is both sonorous and forceful. And it's a performance that ensures that the BMW 6 Series Coupé always gets the best reception.

TOO GOOD-LOOKING FOR THE RACETRACK.



The kidney grille of the BMW 6 Series Coupé instantly and elegantly expresses the consistently dynamic character of this vehicle – a promise more than satisfied on the road. Precise steering coupled with seemingly endless acceleration capacity give every drive exhilarating motor sport feel.



SUN

M RM 2454

An experience of light, air and flowing lines – the BMW 6 Series Convertible. This enthralling overall impression is perfectly complemented by fine details such as contrast stitching in the exclusive Cognac/Black Nappa leather. And it all comes together to create another world where driving under the open skies is a truly unique pleasure.

**DRIES TEARS OF JOY
IN THE AIRSTREAM.**





ITS ELEGANCE IS AN OPEN SECRET.

For all to see, but only you can feel it: take the highly functional and ergonomically designed steering wheel into your hands. Discover the select interior materials and the comfort of the bi-colour leather seats – and experience luxury and elegance that will delight you again and again.



THE OUTLOOK: LUXURIOUS TO SPORTY.

Luxurious. Sporty. Elegant. Values that make each BMW 6 Series model unmistakable and also unique in themselves. Which means that the Gran Coupé, the Coupé and the Convertible are always to be found exactly where they belong: at the centre of attention.



INNOVATION AND TECHNOLOGY.

BMW TWIN POWER TURBO ENGINES: At the heart of BMW EfficientDynamics.

BMW EFFICIENT DYNAMICS: The joys of reducing consumption.

BMW CONNECTED DRIVE: Services & Apps and driver assistance.

CHASSIS: Innovative systems for more driving pleasure.

SAFETY: Technology at the highest level.

BMW TwinPower Turbo engines. At the heart of BMW EfficientDynamics.

Thanks to BMW TwinPower Turbo technology, the innovative new generation of BMW petrol and diesel engines from the BMW EfficientDynamics engine range can deliver an agile performance and excellent responsiveness even at low engine speeds, all while being exceptionally fuel efficient and low in emissions. Increased efficiency and optimal dynamics guarantee noticeably more intense driving pleasure.



BMW TWIN POWER TURBO 8-CYLINDER 650i PETROL ENGINE.

Commanding acceleration – all any BMW driver could wish for: thanks to its exceptional responsiveness and high power reserves, the **BMW TwinPower Turbo 8-cylinder petrol engine** from the EfficientDynamics engine range impresses in every situation. This powerhouse combines two turbochargers with Valvetronic fully variable valve control including Double-VANOS and High Precision Injection with solenoid injectors. At engine speeds between 2,000 and 4,500 rpm, it generates impressive maximum torque of 650 Nm. With a maximum output of 330 kW (450 hp), the V8 propels the vehicle from 0 to 100 km/h in a mere 4.6 seconds.

BMW EFFICIENT DYNAMICS.
LESS EMISSIONS. MORE DRIVING PLEASURE.

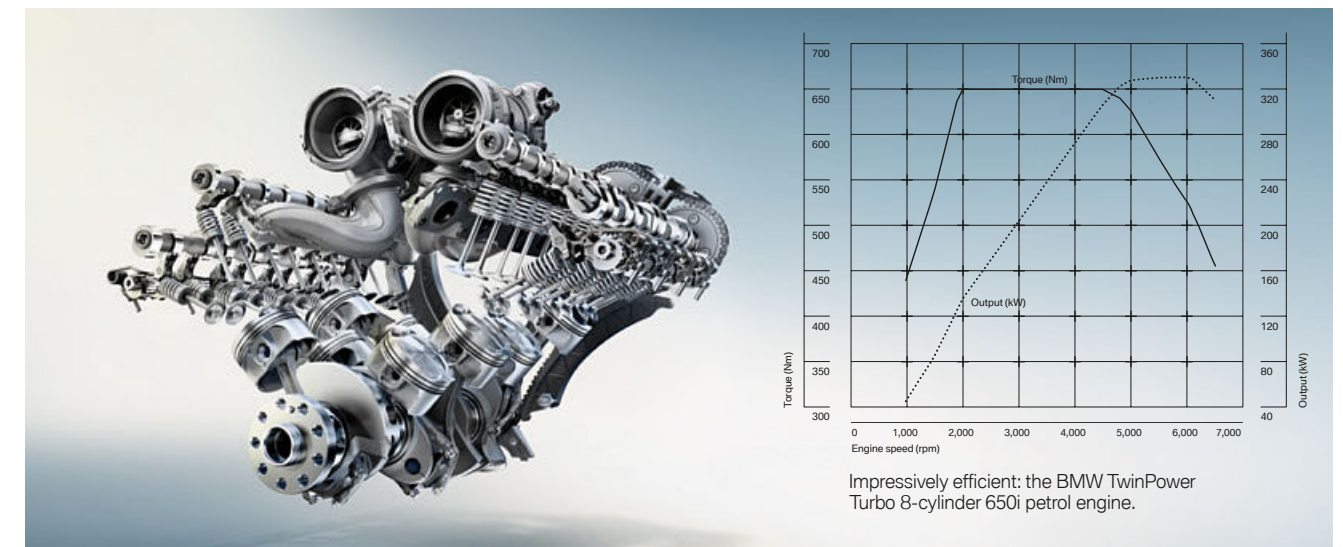

BMW 640i. Gran Coupé / Coupé / Convertible

- BMW TwinPower Turbo inline 6-cylinder petrol engine with 235 kW (320 hp) and 450 Nm of torque
- Acceleration 0–100 km/h: 5.4 s / 5.3 s / 5.5 s;
Top speed: 250 km/h¹ / 250 km/h¹ / 250 km/h¹
- Combined fuel consumption: 7.6–7.8 l/100 km² / 7.6–7.7 l/100 km² / 7.7–7.9 l/100 km²
- Combined CO₂ emissions: 178–182 g/km² / 176–180 g/km² / 179–184 g/km²

BMW 650i. Gran Coupé / Coupé / Convertible

- BMW TwinPower Turbo 8-cylinder petrol engine with 330 kW (450 hp) and 650 Nm of torque
- Acceleration 0–100 km/h: 4.6 s / 4.6 s / 4.6 s;
Top speed: 250 km/h¹ / 250 km/h¹ / 250 km/h¹
- Combined fuel consumption: 8.6–8.8 l/100 km² / 8.6–8.8 l/100 km² / 8.9–9.1 l/100 km²
- Combined CO₂ emissions: 199–206 g/km² / 199–206 g/km² / 208–213 g/km²

BMW 640d. Gran Coupé / Coupé / Convertible

- BMW TwinPower Turbo inline 6-cylinder diesel engine with 230 kW (313 hp) and 630 Nm of torque
- Acceleration 0–100 km/h: 5.4 s / 5.3 s / 5.5 s;
Top speed: 250¹ km/h / 250¹ km/h / 250¹ km/h
- Combined fuel consumption: 5.5–5.7 l/100 km² / 5.4–5.5 l/100 km² / 5.6–5.8 l/100 km²
- Combined CO₂ emissions: 147–152 g/km² / 143–147 g/km² / 149–153 g/km²

BMW 640i xDrive. Gran Coupé / Coupé / Convertible

- BMW TwinPower Turbo inline 6-cylinder petrol engine with 235 kW (320 hp) and 450 Nm of torque
- Acceleration 0–100 km/h: 5.3 s / 5.2 s / 5.4 s;
Top speed: 250 km/h¹ / 250 km/h¹ / 250 km/h¹
- Combined fuel consumption: 8.1–8.2 l/100 km² / 8.0–8.2 l/100 km² / 8.2–8.4 l/100 km²
- Combined CO₂ emissions: 188–192 g/km² / 187–191 g/km² / 191–195 g/km²

BMW 650i xDrive. Gran Coupé / Coupé / Convertible

- BMW TwinPower Turbo 8-cylinder petrol engine with 330 kW (450 hp) and 650 Nm of torque
- Acceleration 0–100 km/h: 4.4 s / 4.4 s / 4.5 s;
Top speed: 250 km/h¹ / 250 km/h¹ / 250 km/h¹
- Combined fuel consumption: 9.2–9.4 l/100 km² / 9.1–9.3 l/100 km² / 9.3–9.5 l/100 km²
- Combined CO₂ emissions: 215–219 g/km² / 213–217 g/km² / 217–221 g/km²

BMW 640d xDrive. Gran Coupé / Coupé / Convertible

- BMW TwinPower Turbo inline 6-cylinder diesel engine with 230 kW (313 hp) and 630 Nm of torque
- Acceleration 0–100 km/h: 5.2 s / 5.1 s / 5.3 s;
Top speed: 250¹ km/h / 250¹ km/h / 250¹ km/h
- Combined fuel consumption: 5.8–6.0 l/100 km² / 5.6–5.8 l/100 km² / 5.8–6.0 l/100 km²
- Combined CO₂ emissions: 153–158 g/km² / 149–154 g/km² / 154–158 g/km²

¹ Electronically restricted.

² Fuel consumption and CO₂ emission figures are dependent on tyre format (higher figures refer to models with optional wheels). Further information on fuel consumption and CO₂ emissions can be found on pages 64 | 65 or consult your BMW partner.

Performance, fuel consumption and CO₂ emissions figures apply to vehicles with German standard equipment.

BMW EfficientDynamics

Less emissions. More driving pleasure.

Get more out of every litre of fuel with BMW EfficientDynamics: better performance, greater efficiency and a heightened driving experience. Technical innovations that lower fuel consumption while simultaneously increasing driving pleasure mean that pure dynamics come with every BMW.

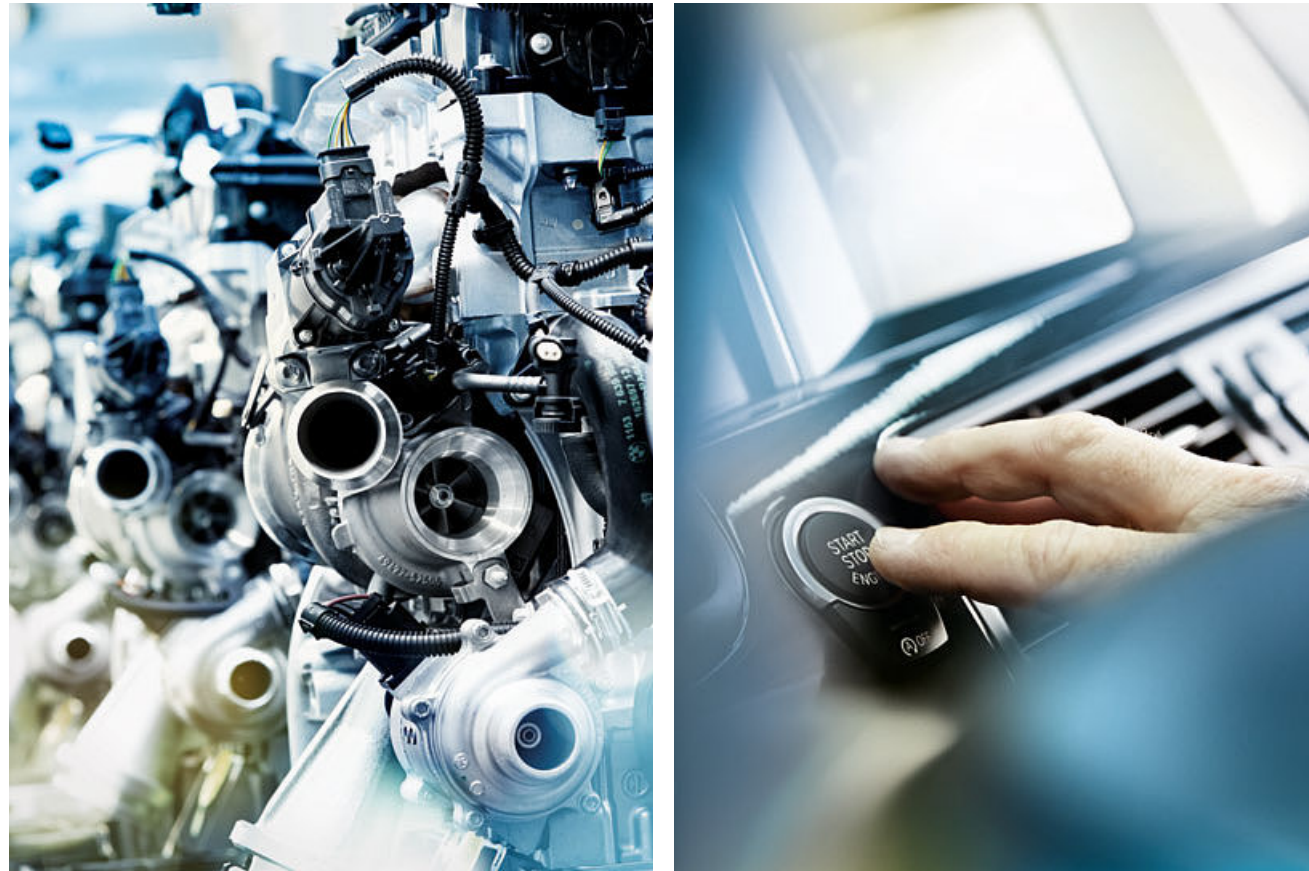

SPORTY AND EFFICIENT: THE 8-SPEED STEPTRONIC SPORT TRANSMISSION.

The **8-speed Steptronic Sport transmission** adapts to suit individual driving styles. It is perfect for everything from comfortable cruising through to a very dynamic drive. As well as automatic gear selection, it is, of course, possible to change gears manually at any time. Gears can be shifted using the dynamically designed selector lever or the shift paddles on the steering wheel.



DRIVETRAIN.

The BMW TwinPower Turbo **petrol engines** feature remarkably dynamic power development and excellent responsiveness, even at low engine speeds. They are also more efficient, with lower emissions and even better performance than their predecessors.

The BMW TwinPower Turbo **diesel engine** is notable for its outstanding responsiveness and spirited power delivery at any engine speed. It is also outstandingly dynamic, highly fuel-efficient and low on emissions.

OVERALL CONCEPT.

Intelligent lightweight construction, for BMW, means using the right material in the right place. This philosophy, also known as the BMW EfficientLightweight concept, is today integral to the BMW EfficientDynamics strategy and is applied, as standard, in every BMW. The result is reduced fuel consumption and even better performance, while maintaining the highest safety standards. The leading example: the BMW 640d Coupé emits only 143–147 g/km of CO₂ (combined), the best figure in its class.¹

ENERGY MANAGEMENT.

ECO PRO mode helps drivers reduce fuel consumption by up to 20 per cent, depending on their driving style and according to an internal BMW study. The coasting function, the route-ahead assistant and ECO PRO route make it possible to save a further five per cent.

The **Automatic Start/Stop function** switches off the engine when the vehicle comes to a temporary standstill (e.g. at traffic lights or in a traffic jam) to further reduce overall fuel consumption. When the driver takes their foot off the brake, the engine automatically starts up again in a fraction of a second.

With **Brake Energy Regeneration**, the alternator generates electricity primarily when the driver brakes or takes their foot off the accelerator. Previously unused kinetic energy is thereby transformed into electrical energy and fed into the battery.

The **coasting function** allows the vehicle to coast along the road at up to 160 km/h when the driver takes their foot off the accelerator without braking. In SPORT mode, the car responds more directly, for a more dynamic driving experience.

¹ Fuel consumption and CO₂ emission figures are dependent on tyre format (higher figures refer to models with optional wheels). Further information on fuel consumption and CO₂ emissions can be found on pages 64 | 65 or or consult your BMW partner.

BMW ConnectedDrive

So connected, you're free.

Our world is becoming more closely connected every day. And for BMW drivers it goes without saying that they can request information, communicate via telephone or email and always be up to date – all while they're on the go. The BMW ConnectedDrive¹ concept encompasses all the services and innovative technologies that link BMW vehicles and their passengers to the outside world and surrounding traffic.



The equipment option **ConnectedDrive Services*** forms the basis for BMW ConnectedDrive functions, which provide the driver with a wide range of information, entertainment and service features while on the road.

These include BMW Online, which provides access to current, location-based information such as weather and news, an online search powered by Google™ as well as office functions. In addition, an individual range of services such as fuel price information, parking information, as well as travel and hotel guides may be set up via the applications menu.

This also includes convenient, secure and unlimited access to selected smartphone apps. ConnectedDrive Services also provides access to the **BMW ConnectedDrive Store**, in which services such as Real Time Traffic Information, Remote Services, Online Entertainment and Concierge Services can easily be ordered and extended to suit the user's individual requirements. The equipment option ConnectedDrive Services offers all this and more, making every trip in a BMW a real experience.

With its intelligent services and assistance systems, BMW ConnectedDrive is ready with a host of solutions to meet your every need. **BMW ConnectedDrive Services & Apps** offer greater freedom by networking the driver, vehicle and outside world in a wide range of ways, and intelligent **BMW ConnectedDrive Driver Assistance systems** make travel in your BMW not only safer, but also more comfortable and convenient.



The optional full-colour **BMW Head-Up Display²** projects all information relevant to the journey directly into the driver's field of vision, thereby allowing full concentration on driving. Information such as the current speed, navigation directions, Speed Limit Info including no-overtaking indicator, along with telephone and entertainment lists are displayed.

The optional **Concierge Services*** connect the driver to a BMW Call Centre agent at the push of a button. The agent can locate a particular restaurant, the nearest cash dispenser or an emergency pharmacy and send the address details directly to the car's navigation system.

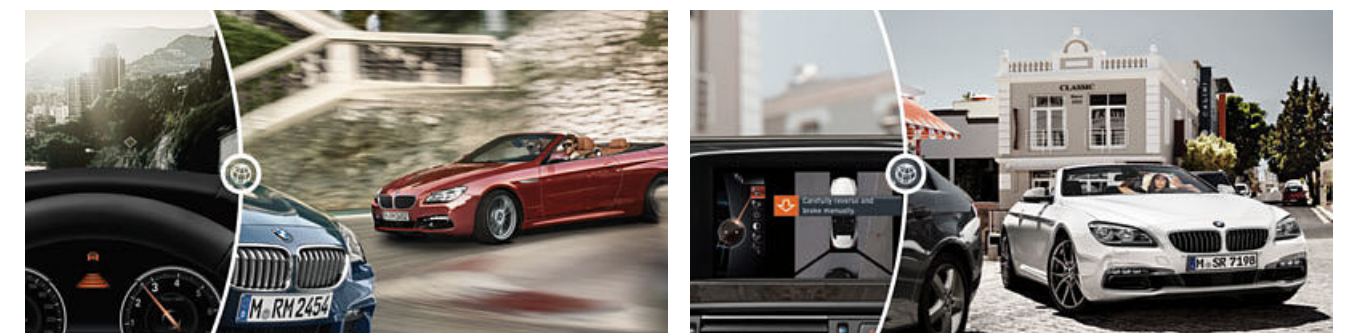

The **Driving Assistant Plus** option not only includes the Driving Assistant systems, Lane Departure Warning and Approach Control and person warning with light city braking function, but also Active Cruise Control with the Stop&Go function for additional comfort.

The optional **Park Assistant** makes parallel parking easier. The system works by measuring potential spaces while driving past at a low speed. When a suitable space has been found, Park Assistant takes over the steering, while the driver is responsible for selecting the correct gear, as well as operating the accelerator and brakes.

* May not be available in all countries. Please consult your BMW partner.

¹ For further information on BMW ConnectedDrive please visit www.bmw.com/ConnectedDrive

² Visibility of the display is limited with polarised sunglasses.

Image shows features that are only available for the German market.

Chassis.

A solid foundation for superior driving dynamics.

A wide range of innovative technology in the BMW 6 Series line-up ensures that you thoroughly enjoy every journey. Many features are also intelligently networked, allowing you to experience maximum driving pleasure in the utmost safety.

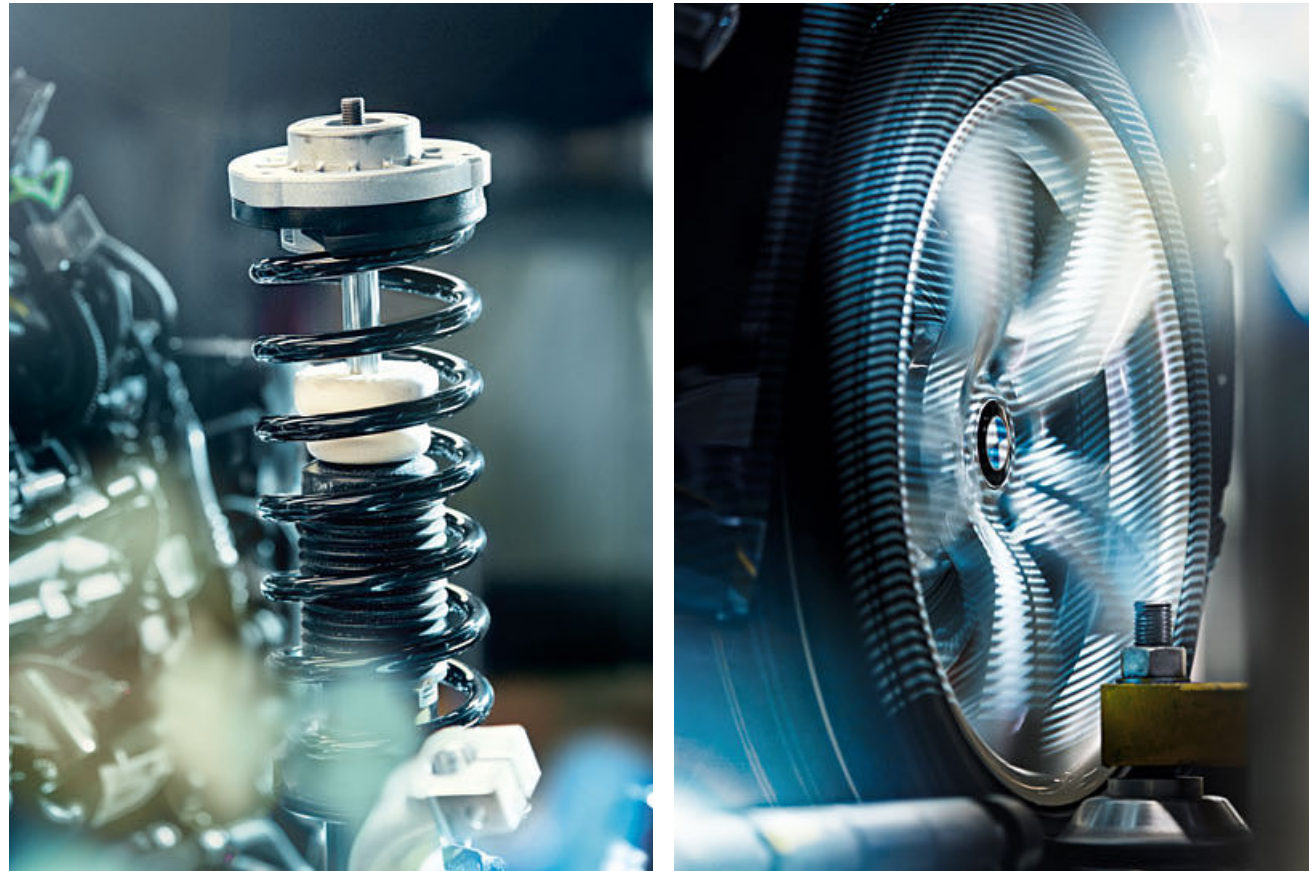

THE INTELLIGENT BMW ALL-WHEEL SYSTEM xDRIVE.

The intelligent BMW xDrive all-wheel drive system adapts perfectly to even the most challenging road surface conditions, ensuring optimal traction at all times. xDrive and Dynamic Stability Control (DSC) ensure that the BMW remains safe and stable. Controlled via the DSC sensor system, xDrive flexibly and quickly distributes drive power between the axles in order to prevent oversteer or understeer on bends, thereby ensuring outstanding directional stability. Moreover, it guarantees a rapid, safe acceleration even on slippery or steep stretches. In critical road conditions, the DSC doesn't need to intervene as much. BMW xDrive thus combines all the advantages of an all-wheel drive system – traction, directional stability and driving safety – with classic BMW agility.

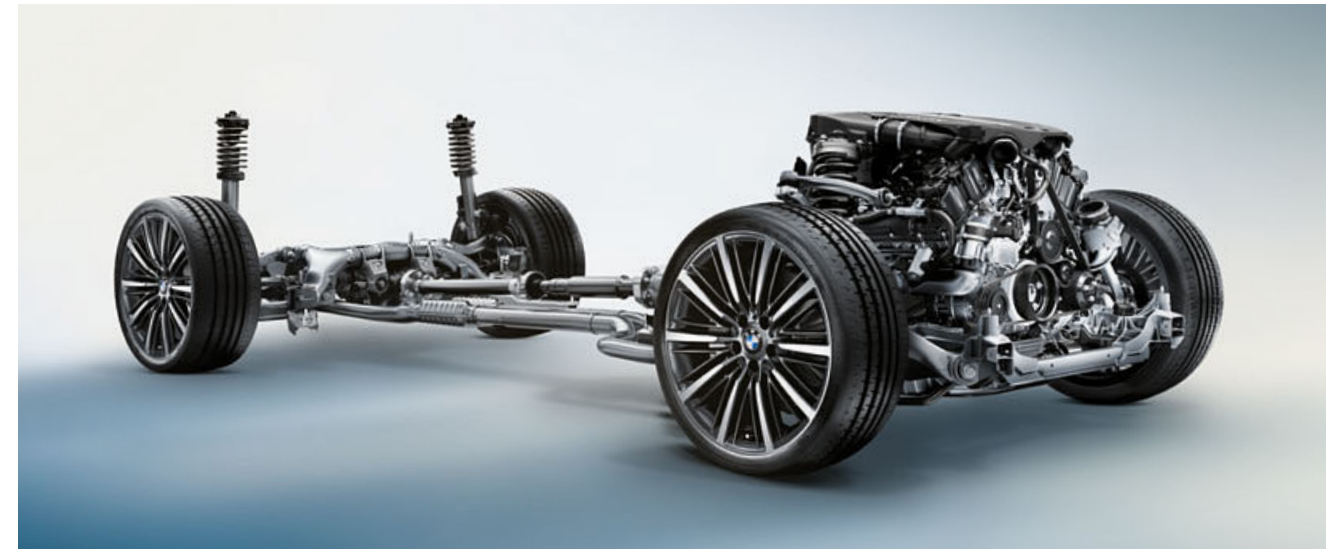

The standard **Sport exhaust system** (not available for 640d and 640d xDrive) delivers a dynamic sound that can be adapted to the driving mode via integrated exhaust flap technology. SPORT and SPORT+, selected using Driving Experience Control, are accompanied by an even more intense sound, while the engine note is more discrete in the comfort-orientated settings.

The standard **eight-speed Steptronic Sport transmission** adapts to suit individual driving styles, ranging from comfortable coasting right through to the most dynamic. In SPORT mode, gear shifts are configured for peak performance. Additionally, Launch Control enables maximum acceleration by automatically up-shifting when the engine is at optimum speed.

Integral Active Steering combines variable Active Steering on the front axle with rear wheels that also contribute to steering based on speed. At lower speeds, it offers greater manoeuvrability and agility by turning the rear wheels in the opposite direction to the front wheels. From around 60 km/h, the rear wheels turn parallel to the front wheels, to increase stability and comfort.

Adaptive Drive combines the active body roll stabilisation functionality of Dynamic Drive and Dynamic Damper Control for need-based control of the stabilisers and dampers. It also provides maximum comfort while driving and more precise steering responses with less body roll. This allows the driver to take curves at greater speeds and enjoy shorter braking distances.

Dynamic Damper Control makes it possible to adapt the damper characteristics to suit any given driving situation. In the standard COMFORT mode, the dampers provide greater cushioning, while SPORT and SPORT+ modes feature much firmer settings for increased precision and more dynamic driving.

The standard **Driving Experience Control** offers the choice between the standard COMFORT mode, efficiency-focused ECO PRO and SPORT or SPORT+, for even more dynamic driving. ECO PRO mode adjusts the throttle and transmission characteristics as well as the heating/air conditioning settings to make the drive as fuel-efficient as possible.

Safety.

Unparalleled safety with the latest BMW technology.

The BMW 6 Series models are full of cutting-edge technology that can always be relied on. Superb handling characteristics and innovative equipment come as standard, giving the driver exactly the right support for any situation. It all means that you can feel safe in all road conditions.



The BMW 6 Series Gran Coupé, Coupé and Convertible are proof that elegance and safety make an ideal partnership. The very latest technology ensures that every drive is both comfortable and safe. For instance, the cornering lights with variable light distribution, included in the Adaptive LED headlights option, respond to your steering input for greatly improved visibility in every corner.

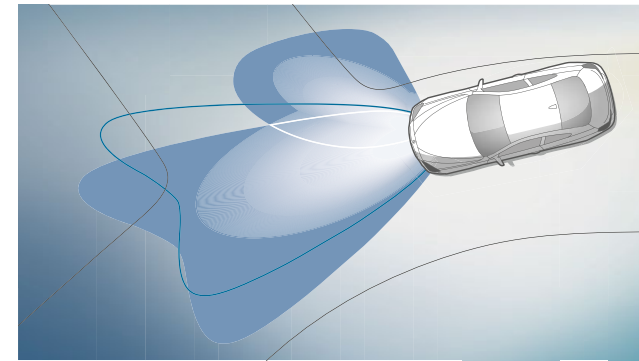

□ **Adaptive headlights** with variable city and motorway light distribution, including cornering lights for optimal road illumination and BMW Selective Beam (anti-dazzle High-beam assistant) with automatic low and high beam.

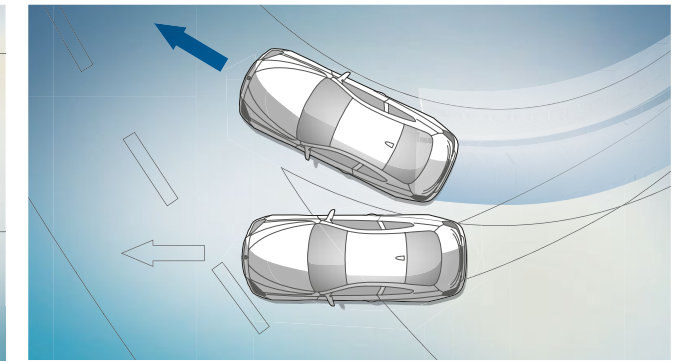

■ **Dynamic Stability Control (DSC)** uses sensors to constantly assess the vehicle's movements and automatically stabilises the car with engine and braking regulation when unstable driving conditions are detected.

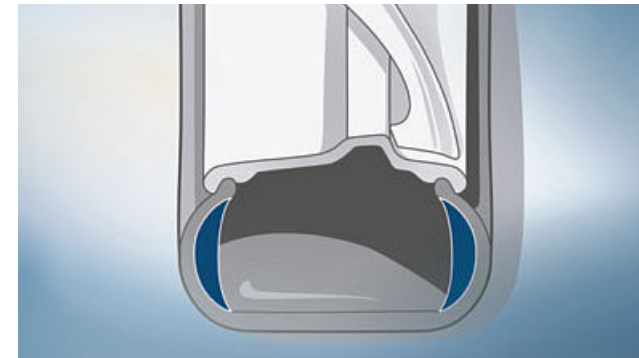

■ The **tyre pressure indicator** keeps the driver informed of pressure loss by means of a sensor. The air temperature is also monitored.

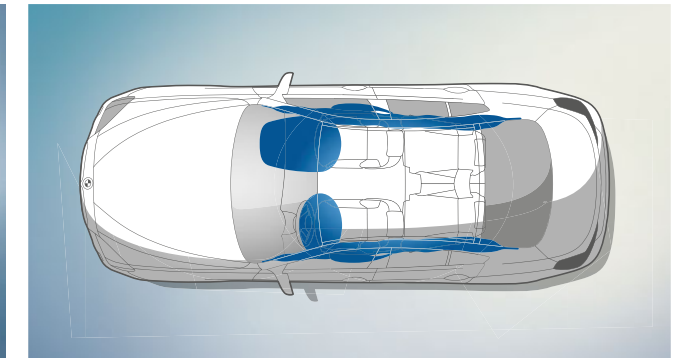

■ The **airbags for the driver and front passenger** are an integral part of the optimally coordinated safety components in a BMW. Overall, up to six airbags provide targeted protection.

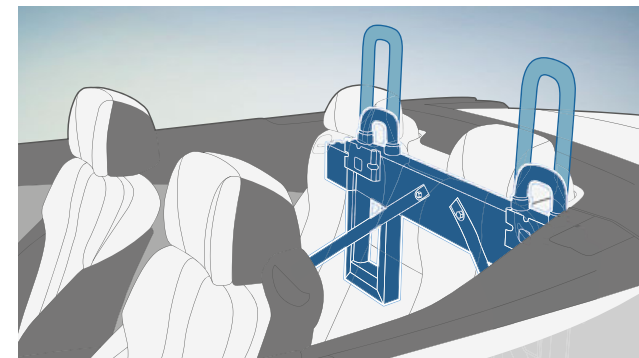

■ The **roll-over protection system¹** includes roll bars integrated into the windscreen frame, as well as concealed roll bars behind the rear headrests. When the vehicle threatens to roll over, a spring-loaded mechanism pushes out the roll bars in fractions of a second.

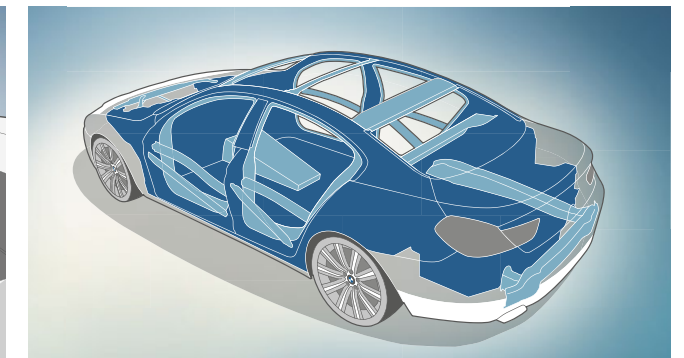

■ The **body** is extremely rigid to ensure the best possible steering precision and dynamic agility. The front and rear are equipped with highly effective deformation zones.

¹ Only available for the BMW 6 Series Convertible.

Optional and standard equipment vary according to country.



INDIVIDUALITY AND VERSATILITY.

EQUIPMENT: BMW Design Pure Excellence, BMW Design Pure Experience, M Sport package and BMW Individual, equipment highlights, wheels and tyres and Original BMW Accessories.

COLOURS: A world of colour for the exterior and interior.

TECHNICAL DATA: Weight, engine, transmission, performance, fuel consumption, wheels and dimensions.

BMW SERVICE: BMW Service, BMW Financial Services and BMW Experience.



BASE.

01



04



02



03



05



06



[01 | 04] The BMW 6 Series Convertible in the optional exterior colour Cashmere Silver metallic and with standard 18" light alloy wheels Star-spoke 365, 8 J x 18 with 245/45 R 18 tyres.¹

[02] The standard Sport leather steering wheel convinces with its satisfying grip. The ConnectedDrive Navigation package* along with the HiFi system with digital amplifier and nine loudspeakers are also standard.

[03] Standard seats for the driver and front passenger with electronic fore-and-aft, seat height, backrest and tilt adjustment.

[05] The elegant design of the interior is particularly enhanced by the standard upholstery in Black Dakota leather and the optional Sport seats.

[06] 18" light alloy wheels Streamline 364 (optional), 8 J x 18 with 245/45 R 18 tyres.¹

*May not be available in all countries. Please consult your BMW partner.
¹ Runflat tyres.

DESIGN PURE EXCELLENCE.

■ Standard equipment □ Optional equipment

Interior equipment

- Seats in Ivory White/Black (Bicolour) exclusive Nappa leather with extended features and contrast stitching; alternatively in Cognac/Black (Bicolour) exclusive Nappa leather with extended features and contrast stitching; other upholstery available
- Contrast stitching with double-lapped seams in a colour complementing the upholstery on the upper part of the instrument panel, doors and side panels as well as the centre console
- Poplar Grain Grey fine-wood trim; alternatively, Finition Brown fine-wood trim; other interior trims available
- Ceramic surrounds for controls (gear selector, iDrive Controller, audio and air conditioning)
- Instrument panel with leather finish
- Ambient light with LED interior lights and illuminated doorsill finishers

Can be combined with all optional BMW interior trims¹, BMW Individual interior trims and all BMW Individual leather upholstery.

Exterior equipment

- Metallic paint
- 19" light alloy wheels V-spoke 366 with mixed tyres³; other wheels available
- LED foglights

Can be combined with all paint colours, BMW 19" and 20" (optional) wheels and the 20" BMW Individual light alloy wheels V-spoke 374 I.



[01] Elegant details: the leather-finished instrument panel with contrast stitching is beautifully balanced against the Poplar Grain Grey fine-wood trim.



[02] The seats² in Ivory White/Black Bicolour exclusive Nappa leather with extended features and contrast stitching are a real eye-catcher.



03 □



[03 | 06] The BMW 6 Series Gran Coupé in the Jatoba metallic paint finish and with BMW 19" light alloy wheels V-spoke 366 with mixed tyres³.

[04] Illuminated doorsill finishers and colour-matched floor mats are included with the Design Pure Experience package.

[05] Exceptional quality: ceramic surrounds for the gear selector, iDrive Controller, audio and air conditioning controls.



06 □



[07] The Poplar Grain Grey fine-wood trim blends exceptionally well with the interior.

[08] 19" light alloy wheels W-spoke 423 with mixed tyres. Front: 8.5 J x 19 with 245/40 R 19 tyres. Rear: 9J x 19 with 275/35 R 19 tyres.^{3,4}

¹ Aluminium Hexagon (4MR) interior trim not available in conjunction with Design Pure Excellence.
² Design Pure Excellence only available in conjunction with electrically adjustable front comfort seats.

³ Runflat tyres.
⁴ Only available for the BMW 6 Series Gran Coupé.
 Optional and standard equipment vary according to country.

DESIGN PURE EXPERIENCE.

■ Standard equipment □ Optional equipment

Interior equipment:

- Seats in Cognac/Black (Bicolour) exclusive Nappa leather with extended features and contrast stitching; alternatively, seats in Ivory White/Black (Bicolour) exclusive Nappa leather with extended features and contrast stitching; other upholstery available
- Finesse Brown fine-wood trim; alternatively, Poplar Grain Grey fine-wood trim; other interior trims available
- Ambient light includes: lights on the front door pockets, doors and side panels, upper side panels in the rear, storage compartment in the armrest, an additional light on the inside of the tailgate, as well as illuminated front doorsill finishers with metal inlays, exterior door handles featuring chrome inserts and vicinity lighting on the doors

Can be combined with all optional BMW interior trims¹, BMW Individual interior trims and all BMW Individual leather upholstery.

Exterior equipment:

- Metallic paint
- 19" light alloy wheels Star-spoke 367 with mixed tyres³; other wheels available
- BMW Individual high-gloss Shadow Line
- BMW kidney grille with exclusively designed slats with fronts in high-gloss Black, sides in matt Black and grille frame in chrome
- Front bumper with side air inlet surrounds and bars in high-gloss Black
- Rear apron with trim strip in high-gloss Black
- Exhaust tailpipe trim in Black chrome
- LED foglights

Can be combined with all paint colours, BMW 19" and 20" (optional) wheels and the 20" BMW Individual light alloy wheels V-spoke 374 I.



[01] The Sport leather steering wheel with multifunction buttons and chrome trim lies particularly well in the hands.



[02] The seats² in Cognac/Black (Bicolour) exclusive Nappa leather create an interior atmosphere of sporty elegance.



03 □



04 ■



05 ■



06 □



07 □



08 ■

[03 | 06] The BMW 6 Series Gran Coupé in the Space Grey metallic exterior colour and with BMW 20" light alloy wheels Multi-spoke 616 with mixed tyres³.

[04] The air inlets and bars in the front bumper are finished in high-gloss Black.

[05] Illuminated doorsill finishers and colour-matched Velour floor mats are included in the Design Pure Experience package.

[07] 20" light alloy wheels V-spoke 356 with mixed tyres. Front: 8.5 J x 20 with 245/35 R 20 tyres. Rear: 9 J x 20 with 275/30 R 20 tyres³.

[08] 19" light alloy wheels Star-spoke 367 with mixed tyres. Front: 8.5 J x 19 with 245/40 R 19 tyres. Rear: 9 J x 19 with 275/35 R 19 tyres³.

¹ Aluminium Hexagon interior trim (4MR) not available in conjunction with Design Pure Experience.
² Design Pure Experience only available in conjunction with electrically adjustable front Comfort seats.
³ Runflat tyres.

M SPORT PACKAGE.

powered by 

■ Standard equipment □ Optional equipment

Interior equipment:

- M doorsill finishers and M driver footrest
- Sport seats for driver and front passenger in Anthracite/Black Alcantara/Nappa leather combination; other upholstery available
- BMW Individual Anthracite headliner
- BMW Individual Alcantara or Alcantara Anthracite headliner
- M leather multifunction steering wheel
- Interior trim in Aluminium Hexagon; other interior trims available

Can be combined with all BMW leather equipment as well as all BMW Individual leather upholstery.

Exterior equipment:

- 19" M light alloy wheels Double-spoke 351 M with mixed tyres
- 20" M light alloy wheels Double-spoke 373 M with mixed tyres
- M Aerodynamics package with front apron and side skirts in body colour and rear apron with diffuser insert in Dark Shadow metallic
- BMW Individual high-gloss Shadow Line
- 'M' designation on the sides
- Exhaust tailpipes in dark chrome
- Brake calipers painted in black
- LED foglights
- Exclusive Carbon Black metallic paint finish

Can also be combined with other BMW metallic paint finishes and BMW Individual paint finishes.

03 □



[01] The M leather steering wheel with multifunction buttons and the Aluminium Hexagon interior trim give the interior a particularly sporty feel.



[02] Optional comfort seats for the driver and front passenger in Vermilion Red exclusive Nappa leather combine perfect lateral hold with high comfort.

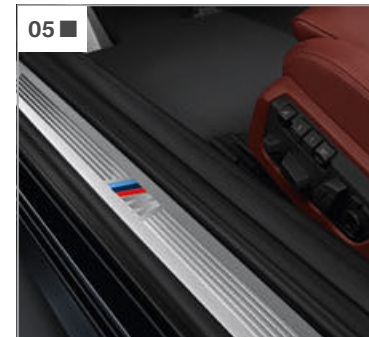

[04] Trapezoidal double tailpipes (only for 650i/650i xDrive), on the left and right sides, with dark chrome trim.

[05] When the door is opened, the eyes are immediately drawn to the M doorsill finisher.



[06] The BMW 6 Series Convertible in the Carbon Black metallic paint finish with 20" M light alloy wheels Double-spoke 373 M with mixed tyres¹.

[07] 20" M light alloy wheels Double-spoke 373 M with mixed tyres. Front: 8.5 J x 20 with 245/35 R 20 tyres. Rear: 9 J x 20 with 275/30 R 20 tyres¹.

[08] 19" M light alloy wheels Double-spoke 351 M with mixed tyres. Front: 8.5 J x 19 with 245/40 R 19 tyres. Rear: 9 J x 19 with 275/35 R 19 tyres¹.



BMW Individual

The expression of personality.



BMW Individual paint finish Tanzanite Blue metallic and 20" light alloy wheels V-spoke 374 I.



The BMW 6 Series Convertible. Inspired by BMW Individual.

Driving a BMW is, in itself, a mark of character. There are those who still, however, want their vehicles to be even more individual reflections of their personality. The BMW Individual Collection and the BMW Individual Manufaktur meet these needs by opening up seemingly limitless opportunities for differentiation.

Precisely in tune with each model, the BMW Individual Collection offers a highly exclusive selection of equipment options. Fascinating paint finishes either refracting the light or with a matt effect. Leather, unique in colour and scope of application, perfected with clever contrasts. Interior trims in the most exclusive fine woods or the immaculate Piano finish.

And yet even all this can be surpassed – thanks to the BMW Individual Manufaktur. Here, there is only one goal: realising almost any customer request, even the most personal, with stylish, hand-crafted perfection.



BMW Individual full fine-grain Merino leather Opal White with stitching and piping in contrast colour.



BMW Individual full fine-grain Merino leather Opal White with stitching and piping in contrast colour and fine-wood trim Ash Grain White.



EXPERIENCE BMW INDIVIDUAL INTERACTIVE.
WITH THE BMW INDIVIDUAL APP FOR iOS AND ANDROID.

EQUIPMENT HIGHLIGHTS.

■ Standard equipment □ Optional equipment

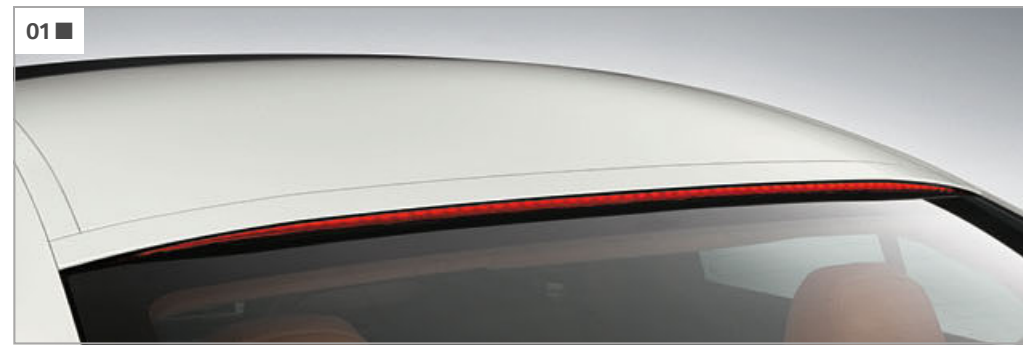

01 ■



05 □



08 ■



11 □



02 □



06 □



03 ■



09 ■



13 ■



04 □



07 ■



10 □



12 ■

[01] The third brake light of the BMW 6 Series Gran Coupé is integrated over the entire width of the roof edge, adding an unmistakable accent to the rear.

[03] The heated rear window can be lowered independently of the soft-top. It provides excellent ventilation and extra comfort for passengers in the rear.

[05] The large glass roof lets plenty of light into the car, creating the comfortable feeling of a generously proportioned, airy interior.

[02] The light generated by the LED fog lights is very similar to daylight and enables the driver to see better and drive more safely in inclement weather.¹

[04] The wind deflector provides the driver and front passenger with effective protection from draughts. When it is not needed, it can be stored compactly.

[06] Adaptive LED headlights provide significantly better illumination and visibility than conventional systems in every driving situation.

[07] The soft-top, available in three colours, opens and closes fully automatically at speeds of up to 40 km/h at the touch of a button. It also features a rear window that can be lowered.

[08] "Gran Coupé" is elegantly positioned in the Hofmeister kink.

[11] With BMW Individual high-gloss Shadow Line, a host of features and design details are finished in high-gloss Black for a particularly elegant look.

[13] Trapezoidal tailpipes, visible, one on the left and one on the right-hand side, with chrome trim (standard for 650i/650i xDrive).

[09] Kidney grille with chrome surrounds and black slats (standard for the 640i/640i xDrive, 640d/640d xDrive) and in matt aluminium (standard for the 650i/650i xDrive) with chrome-lock fronts.

[12] The valve-operated, active Sport exhaust system delivers a discreet or full-bodied and dynamic engine sound – depending on the driving mode.²

[14] Exhaust tailpipe, circular, one on the left and one on the right-hand side, with chrome trim (standard for 640i/640i xDrive and 640d/640d xDrive).

[10] The intelligent BMW xDrive all-wheel drive system smoothly distributes variable drive power to the front and rear wheels.

EQUIPMENT HIGHLIGHTS.

■ Standard equipment □ Optional equipment



[01] Sport leather steering wheel, black, three-spoke, with trim in Pearl Chrome.

[04] The 8-speed Steptronic Sport transmission offers the choice between several driving modes and dynamic shifting via the gearshift paddles or gear lever.

[07] Launch Control enables maximum acceleration from a standing start, with upshifts taking place automatically at the optimum engine speeds.

[02] The instrument cluster features four analogue displays – speedometer, rev counter, fuel gauge and oil temperature – as well as an Info Display. The latter shows data such as the outside temperature and on-board computer functions.

[05] BMW Individual leather steering wheel with wood inlay to match the BMW Individual interior trim.

[08] The iDrive Touch Controller: intuitive operation via the iDrive Controller touchpad.

[03] The multifunctional instrument display offers an impressive presentation of the gauges and other instruments.

[06] Driving Experience Control offers the choice between the standard COMFORT or COMFORT+¹ modes, ECO PRO mode, geared towards efficiency, and SPORT or SPORT+ modes.

[09] The instrument panel with leather finish, including door panels, lends the interior a refined atmosphere.

[10] Exclusive ceramic surrounds for controls such as the gear lever and temperature and volume dials lend a particularly high-quality look.

[11] Real Time Traffic Information* delivers almost instant traffic information on motorways, country roads and main roads, as well as numerous urban routes.

[12] Contrast stitching, complementing the respective upholstery colour, gives the interior an even more exclusive look.

[13] The intelligent emergency call* automatically establishes a connection with the nearest rescue coordination centre through the BMW call centre whenever needed – without the use of a mobile phone.

[14] The ConnectedDrive Navigation package²* comprises the Navigation System Professional, enhanced telephony, Concierge Services, RTTI, Remote Services and BMW ConnectedDrive Services.

[15] BMW Night Vision with person recognition warns when there are people or large animals on the road at night and represents the area in front of the vehicle as an infrared image on the Control Display.

[16] Preparation for Apple CarPlay® supports the convenient and secure wireless use of an iPhone® via the vehicle's user interface.³

[17] Convenience telephony with extended smartphone connectivity^{3,4} allows a mobile phone to be connected to the vehicle via Bluetooth and used with a hands-free kit (not pictured).

[18] The WLAN Hotspot in the vehicle enables access to a tariff-based LTE-standard WLAN hotspot (part of the ConnectedDrive Navigation package*, not shown).

¹ COMFORT+ mode is available in conjunction with Dynamic Damper Control (optional) or Adaptive Drive (optional).

² Further information on BMW ConnectedDrive, in particular, duration of services and costs, is available at www.bmw.com/ConnectedDrive

³ Part of the ConnectedDrive Navigation package.

⁴ Information on Bluetooth compatibility of smartphones and other mobile devices is available at www.bmw.com/bluetooth.

⁵ The availability and range of functions of Apple CarPlay® may vary from country to country.

* May not be available in all countries. Please consult your BMW partner.

Optional and standard equipment vary according to country.

EQUIPMENT HIGHLIGHTS.

■ Standard equipment □ Optional equipment

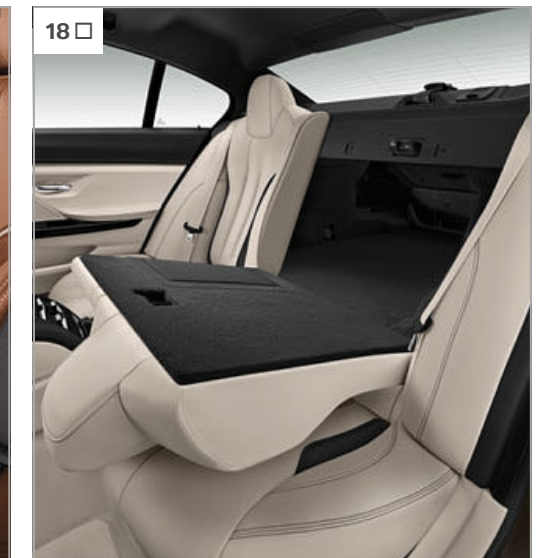
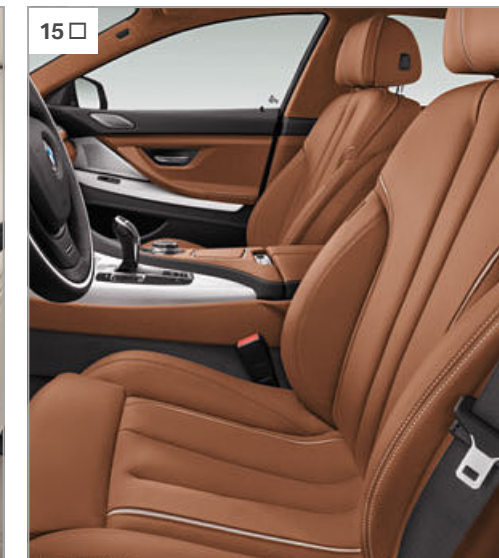
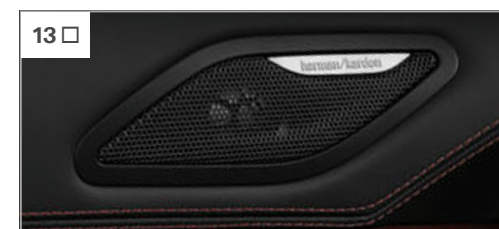
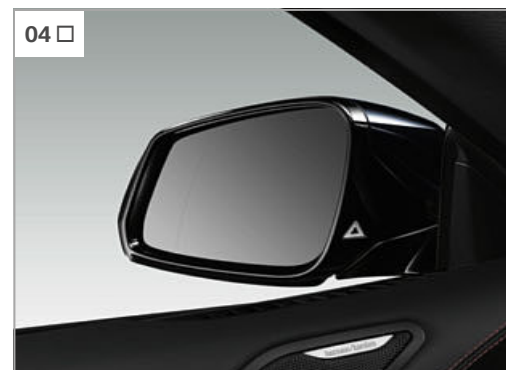
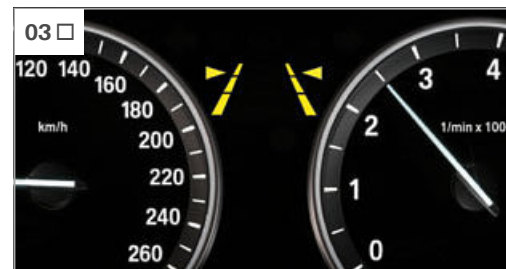

[01] The full-colour BMW Head-Up Display¹ projects all information relevant to the journey directly into the driver's field of vision.

[02] Speed Limit Info including No-overtaking indicator collects information on speed limits and overtaking rules and shows them to the driver.

[03] Driving Assistant Plus includes the very latest warning and collision protection functions and offers additional comfort in monotonous traffic situations.

[04] Lane Change Warning alerts the driver to vehicles in the blind spot as well as vehicles in the neighbouring lane by means of a visual signal and vibration in the steering wheel.

[05] The Sport seats for driver and front passenger, featuring distinctive stitching, provide optimum lateral hold thanks to pronounced contouring of the backs and sides.

[06] Automatic air conditioning with 2-zone control allows individual temperature adjustment for the driver and front passenger.

[07] The Park Assistant² makes parallel parking easier. It does the steering while the driver operates the accelerator and brakes.

[08] Surround View is a visual parking aid that uses the camera-based functions Top View, Side View and the rear view camera.

[09] The automatic air conditioning with 4-zone control allows passengers to individually adjust the temperature for every seat.⁵

[10] Telephony with Wireless Charging³ comprises, among other features, a cradle for wireless charging, Bluetooth, USB and NFC interfaces plus Bluetooth Office (part of the ConnectedDrive Navigation package*).

[11] Comfort seats for driver and front passenger include active headrests in the optional Ivory White/Black (Bicolour) exclusive Nappa leather.

[12] The Bang & Olufsen high-end surround sound system enthral listeners with its full sound, illumination effects and extendible centre speaker.

[13] Harman Kardon Surround Sound system with 600-watt digital amplifier, nine channels, vehicle-specific equalizer and 16 loudspeakers⁵, including centre speaker.

[14] The seat heating for driver and front passenger heats the seat surface and middle section of the backrest to one of three levels, as desired.

[15] Comfort seats for driver and front passenger include active headrests and can be specifically adjusted: the top part of the backrests, the backrest widths, thigh supports and headrest heights.

[16] Ambient light is featured in areas such as the centre console storage compartment, the door pockets and panels, the door handles, the exit areas and the area in front of the doors.⁴

[17] The volume of the luggage compartment can be increased from 460 (Convertible: up to 350) to 1,265 litres (BMW 6 Series Gran Coupé) by folding down the 60:40-dividable rear backrests.

[18] The through-loading system with a rear seat backrest that can be folded down in a 60:40 split offers variable, extendible transport options.⁶

¹ Visibility of the display is limited by polarised sunglasses. BMW Head-Up Display functionality shown is dependent on equipment.

² Image shows features that require the purchase of optional equipment.

³ Only available in conjunction with Park Distance Control.

⁴ Inductive charging in the centre console smartphone holder meets the Qi standard for compatible mobile phones. Special holders for selected smartphones without Qi-standard inductive charging functionality are available from BMW Parts and Accessories.

⁵ Standard in conjunction with Design Pure Excellence and Design Pure Experience.

⁶ BMW 6 Series Convertible: 12 loudspeakers.

⁷ Only for BMW 6 Series Gran Coupé.

* May not be available in all countries. Please consult your BMW partner.

Optional and standard equipment vary according to country.

WHEELS AND TYRES.

■ Standard equipment □ Optional equipment ○ Accessories



[01] 18" light alloy wheels Star-spoke 365, 8 J x 18 with 245/45 R 18 tyres.¹

[04] 18" light alloy wheels Streamline 364, 8 J x 18 with 245/45 R 18 runflat tyres.¹

[07] 20" light alloy wheels V-spoke 356 with mixed tyres. Front: 8.5 J x 20 with 245/35 R 20 tyres. Rear: 9 J x 20 with 275/30 R 20 tyres.¹

[02] 17" light alloy wheels Streamline 363, 8 J x 17 with 225/55 R 17 tyres.

[05] 19" light alloy wheels V-spoke 366 with mixed tyres. Front: 8.5 J x 19 with 245/40 R 19 tyres. Rear: 9 J x 19 with 275/35 R 19 tyres.¹

[08] 20" M light alloy wheels Double-spoke 373 M with mixed tyres. Front: 8.5 J x 20 with 245/35 R 20 tyres. Rear: 9 J x 20 with 275/30 R 20 tyres.¹

[03] 20" light alloy wheels Multi-spoke 616 with mixed tyres. Front: 8.5 J x 20 with 245/35 R 20 tyres. Rear: 9 J x 20 with 275/30 R 20 tyres.¹

[06] 20" BMW Individual light alloy wheels V-spoke 374 I, forged, with mixed tyres. Front: 8.5 J x 20 with 245/35 R 20 tyres. Rear: 9 J x 20 with 275/30 R 20 tyres.¹

[09] 20" light alloy wheels Multi-spoke 410 in gloss Black with burnished rims. RDC complete wheel set with mixed, runflat tyres. Front wheels: 8.5 J x 20. Rear wheels: 9 J x 20.²

[10] 20" BMW M Performance light alloy wheels V-spoke 464 M in Bicolour Ferric Grey, burnished on the visible sides. RDC complete wheel set with mixed, runflat tyres. Front wheels: 8.5 J x 20. Rear wheels: 9 J x 20.²

¹ Runflat tyres.

² These and many more wheels are available from Original BMW Accessories: www.bmw.com/accessories

Optional and standard equipment vary according to country.

ORIGINAL BMW ACCESSORIES.



[01] A powerful impression: the black front grille is a striking, individual feature that emphasises the dynamic character.

[03] Secure docking for the Apple iPad™ 2, 3 or 4. The holder snaps into the basic carrier, rotates through 360 degrees and can be angled as desired.

[04] Dynamic look, individual accent: the striking wing mirror caps in carbon accentuate the high-tech character of the vehicle.

[02] Various snap-in adapters are available for current mobile phones. These enable docking and charging and telephone calls via a connection to the vehicle's aerial.

EXTERIOR COLOURS.

■ Standard equipment □ Optional equipment



■ **Non-metallic** 668 Black □ **Non-metallic** 300 Alpine White¹ □ **Metallic** A96 Mineral White □ **Metallic** A72 Cashmere Silver

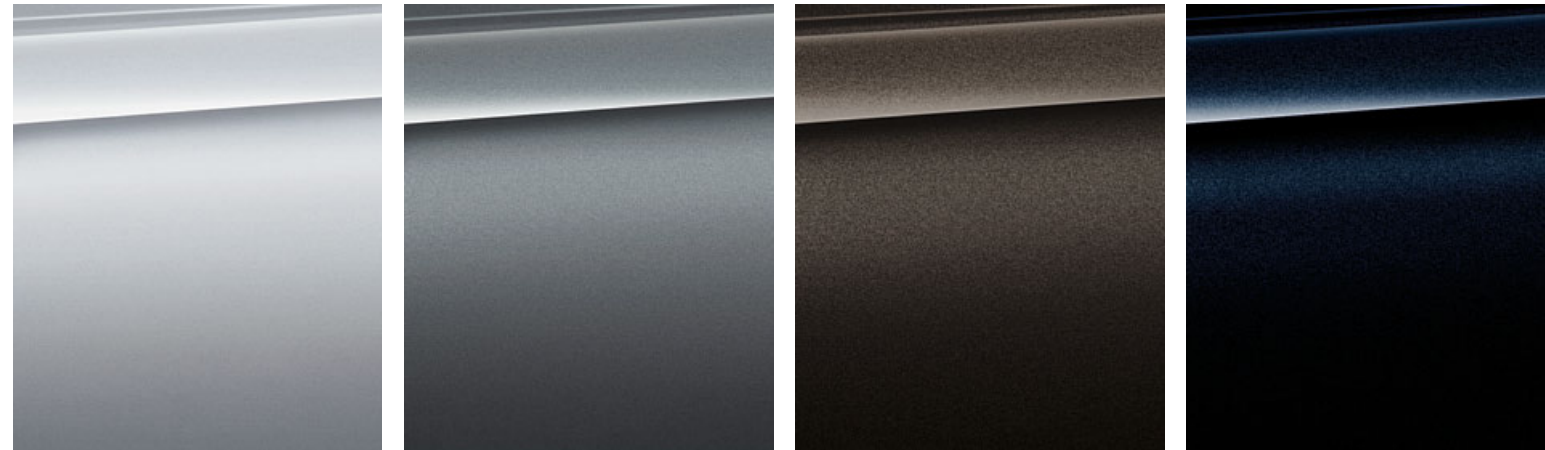

□ **Metallic** A83 Glacier Silver □ **Metallic** A52 Space Grey □ **Metallic** B65 Jatoba □ **Metallic** 416 Carbon Black²

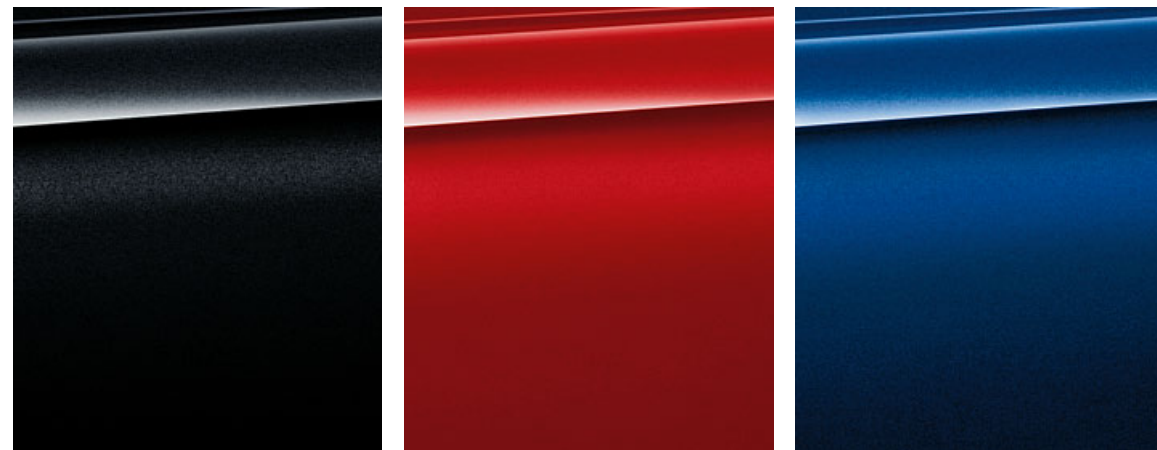

□ **Metallic** 475 Black Sapphire □ **Metallic** A75 Melbourne Red □ **Metallic** C10 Mediterranean Blue

BMW INDIVIDUAL

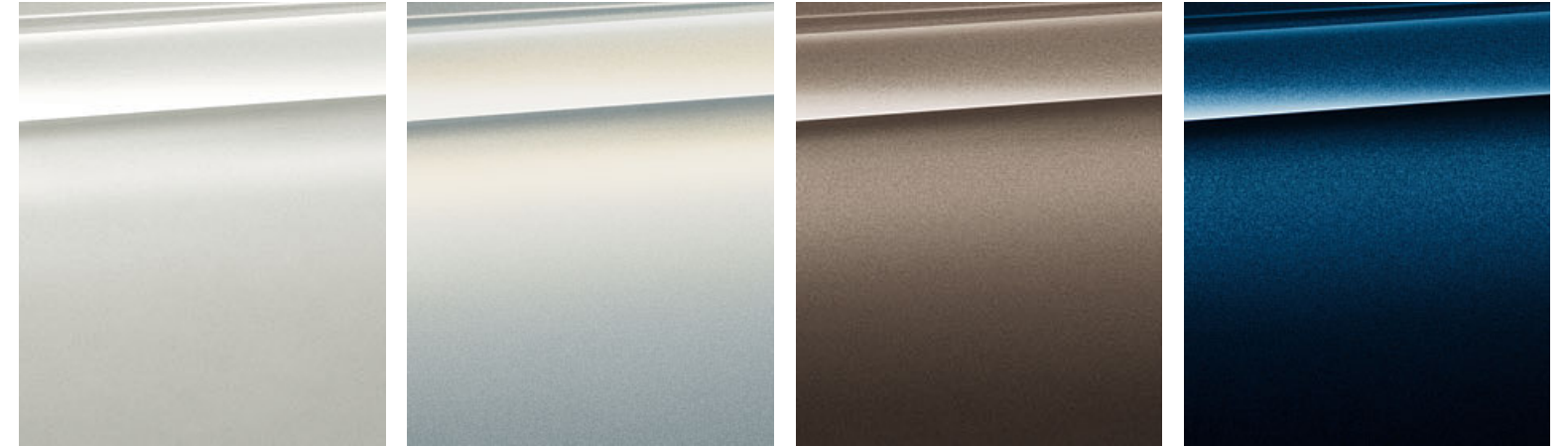

□ **BMW Individual** X16 Frozen Brilliant White metallic³ □ **BMW Individual** X04 Moonstone metallic³ □ **BMW Individual** X11 Frozen Bronze metallic³ □ **BMW Individual** X10 Tanzanite Blue metallic³

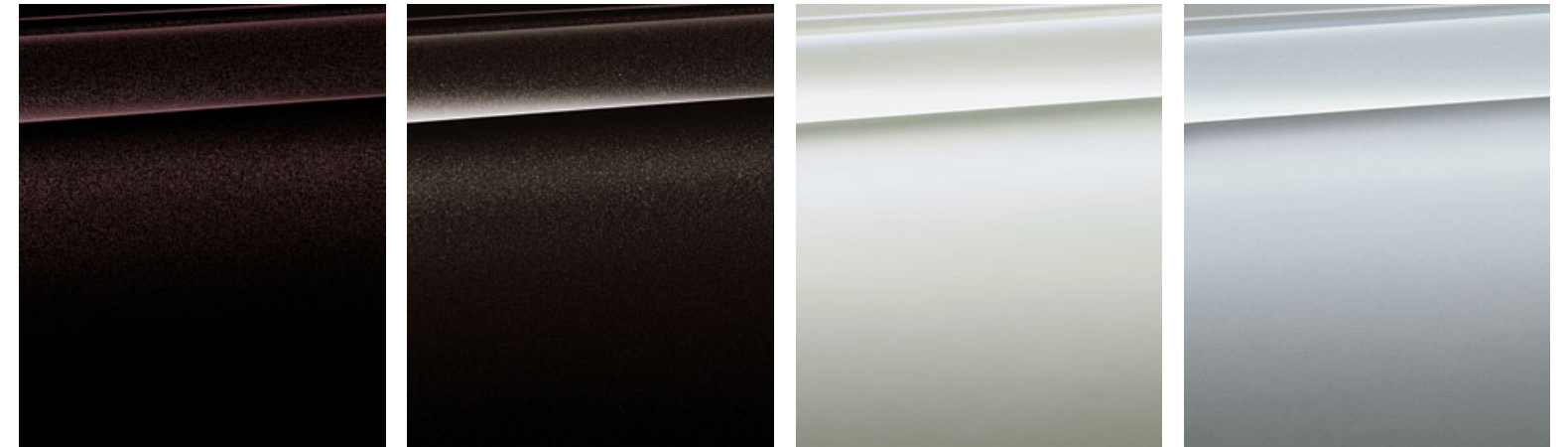

□ **BMW Individual** X03 Ruby Black metallic³ □ **BMW Individual** X02 Citrine Black metallic³ □ **BMW Individual** 490 Brilliant White metallic³ □ **BMW Individual** 490 Pure metal Silver³



□ **BMW Individual** 490 Frozen Silver metallic³ □ **BMW Individual** 490 Frozen Cashmere Silver metallic³ □ **BMW Individual** 490 Frozen Grey metallic³

¹ Available as standard with the M Sport package.
² Only available in conjunction with the M Sport package.
³ Only available in conjunction with optional Park Distance Control (PDC).

Optional and standard equipment vary according to country.

[Colour samples] These samples are meant to give a first impression of paints and materials. Experience has shown, however, that printed versions of paint and upholstery colours cannot in all cases faithfully reproduce the appearance of the originals. We therefore recommend that you consult your BMW partner on your preferred colour choices. They will be happy to show you samples and assist with any special requests.

INTERIOR COLOURS.

■ Standard equipment □ Optional equipment

UPHOLSTERY COLOURS



■ Dakota leather^{1,2} LCSW Black



■ Dakota leather^{1,2} LCEX Ivory White, interior colour Ivory

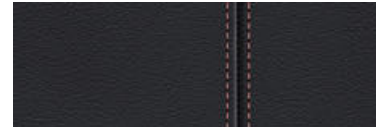

□ Contrast stitching⁶ Vermilion Red

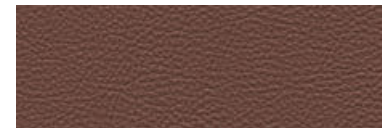

■ Dakota leather^{1,2} LCEZ Cinnamon Brown



□ Exclusive extended Nappa leather^{2,3} NASW Black, interior colour Black



□ Contrast stitching⁶ Ivory White

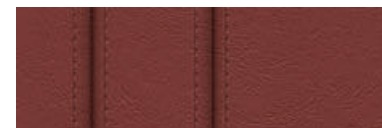

□ Exclusive extended Nappa leather^{2,3} NABY Vermilion Red

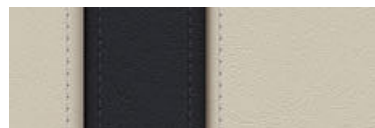

□ Exclusive extended Nappa leather^{2,3} NAEP Ivory White/Black¹³

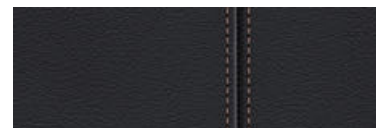

□ Contrast stitching⁶ Cinnamon Brown

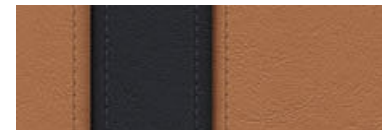

□ Exclusive extended Nappa leather^{2,3} NARQ Cognac/Black¹³



□ Alcantara-Nappa leather combination^{4,5} GPAT Anthracite



□ Contrast stitching⁶ Grey

INTERIOR TRIMS



■ 4AT Black, high-gloss

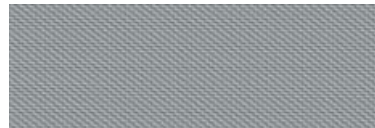

□ 4MR Aluminium Hexagon⁴



■ 388 Black



□ 4AS Fine-wood trim Poplar Grain Grey



□ 3YA Anthracite Silver effect



□ 4E0 Fine-wood trim Finline Brown

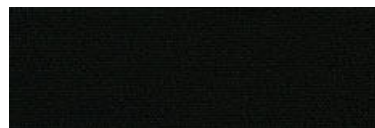

■ Black with headliner in Everest Grey⁷ or in Anthracite⁹



□ 4B9 Fine Brushed Aluminium

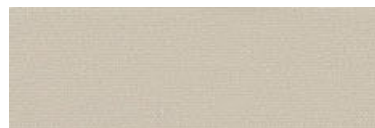

■ Ivory White with headliner in Oyster⁷ or in Anthracite⁹

SOFT-TOP COLOURS



■ 388 Black

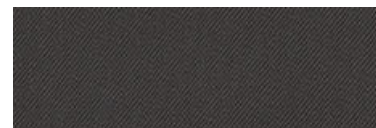

□ 3YA Anthracite Silver effect

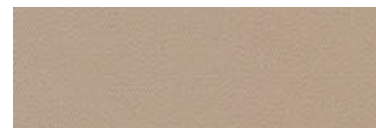

□ 3YE Beige⁹

INTERIOR COLOURS

¹ Dakota leather on the seats and backrests front and rear, headrests and door armrests and rear side panelling.
² Driver and front passenger seats in the BMW 6 Series Convertible feature SunReflective technology.
 BMW Individual fine-grain Merino leather also features SunReflective technology for the rear seats.
³ Exclusive Nappa leather on seats and backrests front and rear, headrests, seat and backrest sides, door panelling, front door armrests as well as rear side panels including armrest.
 Only available in conjunction with comfort seats.

⁴ Only in conjunction with M Sport package.
⁵ Not available in conjunction with contrast stitching.
⁶ Only available in conjunction with leather-finished instrument panel and in the chosen upholstery colour (with Black Dakota leather and Black exclusive Nappa leather, the contrast stitching is in grey).
⁷ Only available for the BMW 6 Series Gran Coupé and BMW 6 Series Coupé.
⁸ Only available for the BMW 6 Series Convertible.
⁹ Only available for the BMW 6 Series Convertible.

BMW INDIVIDUAL

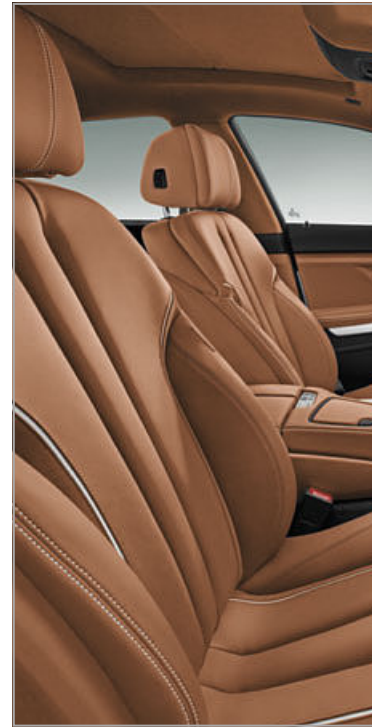

UPHOLSTERY COLOURS



□ BMW Individual full fine-grain Merino leather^{2,10,11} ZBOB Opal White/Amaro Brown¹²



□ BMW Individual full fine-grain Merino leather^{2,10,11} ZBC8 Platinum



□ BMW Individual full fine-grain Merino leather^{2,10,11} ZBP5 Amaro Brown



□ BMW Individual full fine-grain Merino leather^{2,10,11} ZBOW Opal White/Black



□ BMW Individual full fine-grain Merino leather^{2,10,11} ZBP6 Champagne



□ BMW Individual full fine-grain Merino leather^{2,10,11} ZBWT Cohiba Brown

Please note that over time even correct use can lead to unrecoverable upholstery damage. This can be caused in particular by non-colourfast clothing.

BMW INDIVIDUAL



INTERIOR TRIMS



□ BMW Individual interior trim XEX Fine-wood trim Ash Grain White



□ BMW Individual headliner⁷ XD5 Alcantara Platinum

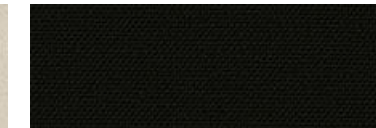

□ BMW Individual headliner⁷ 775 Anthracite



□ BMW Individual interior trim XE5 Fine-wood trim Plane Auburn dark



□ BMW Individual headliner⁷ XD5 Alcantara Champagne

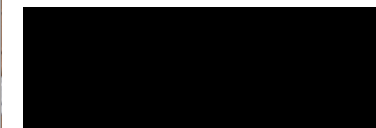

□ BMW Individual interior trim XE7 Piano finish Black



□ BMW Individual headliner⁷ XD5 Alcantara Amaro Brown



□ BMW Individual headliner⁷ 776 Alcantara Anthracite

⁹ Please note that, with the Beige roof, there is an increased risk of soiling due to weather conditions.
¹⁰ BMW Individual full fine-grain Merino leather on front and rear seats including headrests, door panels, centre console including armrest and lower part of the instrument panel. Upper part of the instrument panel, door uprights and lower door panels in Black Walknappa leather.
¹¹ BMW Individual-specific contrast stitching and piping. Not available in conjunction with contrast stitching option 4KS.
¹² Only available for the BMW 6 Series Gran Coupé.

¹³ In conjunction with Design Pure Excellence incl. contrast stitching option 4KS and leather-finished instrument panel option 4ND.

Optional and standard equipment vary according to country.

		640i 640i xDrive Gran Coupé	650i 650i xDrive Gran Coupé	640d 640d xDrive Gran Coupé	640i 640i xDrive Coupé	650i 650i xDrive Coupé	640d 640d xDrive Coupé	640i 640i xDrive Convertible	650i 650i xDrive Convertible	640d 640d xDrive Convertible
--	--	-----------------------------------	-----------------------------------	-----------------------------------	------------------------------	------------------------------	------------------------------	------------------------------------	------------------------------------	------------------------------------

Weight										
Unladen EU ¹	kg	1825	1940	1885	1760	1870	1815	1895	2005	1935
Unladen EU ¹ (xDrive)	kg	1900	2015	1945	1840	1930	1870	1965	2055	2005
Max. permissible	kg	2360	2465	2410	2210	2310	2255	2325	2425	2365
Max. permissible (xDrive)	kg	2430	2550	2470	2265	2365	2315	2390	2480	2440
Permitted load	kg	570	570	570	460	460	460	460	460	460
Permitted load (xDrive)	kg	570	570	570	460	460	460	460	460	460
Permitted trailer load, unbraked ²	kg	750	750	750	-	-	-	-	-	-
Permitted trailer load, unbraked (xDrive) ²	kg	750	750	750	-	-	-	-	-	-
Permitted trailer load, braked, max. 12% gradient/max. 8% gradient ²	kg	1600/1600	1600/1600	1600/1600	-	-	-	-	-	-
Permitted trailer load, braked, max. 12% gradient/max. 8% gradient (xDrive) ²	kg	1600/1600	1600/1600	1600/1600	-	-	-	-	-	-
Luggage compartment capacity min. - max.	l	460-1265	460-1265	460-1265	460	460	460	300-350	300-350	300-350

Engine ^{3,4}										
Cylinders/valves		6/4	8/4	6/4	6/4	8/4	6/4	6/4	8/4	6/4
Capacity	cc	2979	4395	2993	2979	4395	2993	2979	4395	2993
Max. output/engine speed	kW(hp)/ rpm	235 (320)/ 5800-6000	330 (450)/ 5500-6000	230 (313)/ 4400	235 (320)/ 5800-6000	330 (450)/ 5500-6000	230 (313)/ 4400	235 (320)/ 5800-6000	330 (449)/ 5500-6000	230 (313)/ 4400
Max. torque/engine speed	Nm/rpm	450/ 1300-4500	650/ 2000-4500	630/ 1500-2500	450/ 1300-4500	650/ 2000-4500	630/ 1500-2500	450/ 1300-4500	650/ 2000-4500	630/ 1500-2500

Power transmission										
Drive configuration		Rear-wheel/ all-wheel	Rear-wheel/ all-wheel	Rear-wheel/ all-wheel	Rear-wheel/ all-wheel	Rear-wheel/ all-wheel	Rear-wheel/ all-wheel	Rear-wheel/ all-wheel	Rear-wheel/ all-wheel	Rear-wheel/ all-wheel
Standard transmission		Eight-speed Steptronic	Eight-speed Steptronic	Eight-speed Steptronic	Eight-speed Steptronic	Eight-speed Steptronic	Eight-speed Steptronic	Eight-speed Steptronic	Eight-speed Steptronic	Eight-speed Steptronic
Standard transmission (xDrive)		Eight-speed Steptronic	Eight-speed Steptronic	Eight-speed Steptronic	Eight-speed Steptronic	Eight-speed Steptronic	Eight-speed Steptronic	Eight-speed Steptronic	Eight-speed Steptronic	Eight-speed Steptronic

Performance										
Top speed	km/h	250 ⁵	250 ⁵	250 ⁵	250 ⁵	250 ⁵	250 ⁵	250 ⁵	250 ⁵	250 ⁵
Top speed (xDrive)	km/h	250 ⁵	250 ⁵	250 ⁵	250 ⁵	250 ⁵	250 ⁵	250 ⁵	250 ⁵	250 ⁵
Acceleration 0-100 km/h	s	5.4	4.6	5.4	5.3	4.6	5.3	5.5	4.6	5.5
Acceleration 0-100 km/h (xDrive)	s	5.3	4.4	5.2	5.2	4.4	5.1	5.4	4.5	5.3

Fuel consumption ^{3,4}										
Urban	l/100 km	10.7-10.9	11.9-12.3	6.4-6.6	10.5-10.7	11.9-12.3	6.2-6.3	10.7-11.0	12.4-12.7	6.5-6.7
Urban (xDrive)	l/100 km	11.3-11.5	12.9-13.1	6.7-6.8	11.2-11.4	12.7-13.0	6.5-6.7	11.4-11.7	13.0-13.2	6.7-6.8
Extra urban	l/100 km	5.8-6.0	6.6-6.8	5.0-5.2	5.9-6.0	6.6-6.8	4.9-5.1	5.9-6.1	6.9-7.0	5.1-5.3
Extra urban (xDrive)	l/100 km	6.2-6.3	7.1-7.2	5.3-5.5	6.2-6.3	7.0-7.1	5.1-5.3	6.3-6.4	7.1-7.3	5.3v5.5
Combined	l/100 km	7.6-7.8	8.6-8.8	5.5-5.7	7.6-7.7	8.6-8.8	5.4-5.5	7.7-7.9	8.9-9.1	5.6-5.8
Combined (xDrive)	l/100 km	8.1-8.2	9.2-9.4	5.8-6.0	8.0-8.2	9.1-9.3	5.6-5.8	8.2-8.4	9.3-9.5	5.8-6.0
Energy consumption	kWh/100 km	-	-	-	-	-	-	-	-	-
CO ₂ emissions, combined	g/km	178-182	199-206	147-152	176-180	199-206	143-147	179-184	208-213	149-153
CO ₂ emissions, combined (xDrive)	g/km	188-192	215-219	153-158	187-191	213-217	149-154	191-195	217-221	154-158
Tank capacity	l	70	70	70	70	70	70	70	70	70

Wheels										
Tyre dimensions		245/45 R 18 Y	245/45 R 18 Y	245/45 R 18 Y	245/45 R 18 Y	245/45 R 18 Y	245/45 R 18 Y	245/45 R 18 Y	245/45 R 18 Y	245/45 R 18 Y
Wheel dimensions		8 J x 18	8 J x 18	8 J x 18	8 J x 18	8 J x 18	8 J x 18	8 J x 18	8 J x 18	8 J x 18
Material		Light alloy	Light alloy	Light alloy	Light alloy	Light alloy	Light alloy	Light alloy	Light alloy	Light alloy

¹ The figure quoted includes a 90% tank filling, 68kg for the driver and 7kg for luggage. Unladen weight applies to vehicles with standard equipment. Optional equipment may increase this figure.

² The actual overall trailer weight may not exceed the max. permitted trailer load, while taking into account the max. permitted tow bar download.

³ BMW recommends the use of RON 95 super unleaded petrol. Unleaded RON 91 and higher with a maximum ethanol content of 10% (E10) may also be used. Output and consumption figures apply to RON 98 fuel.

⁴ All engines comply with the EU6 emissions standard. Fuel consumption is determined in accordance with the ECE driving cycle (93/116/EC) made up of approximately one-third urban traffic and two-thirds extra-urban driving (based on the distance covered). CO₂ emissions are measured in addition to fuel consumption. Optional equipment may increase these figures. Fuel consumption and CO₂ emissions figures depend on the selected wheel/tyre size. For further information consult your BMW partner.

⁵ Electronically restricted

BMW 6 Series Gran Coupé

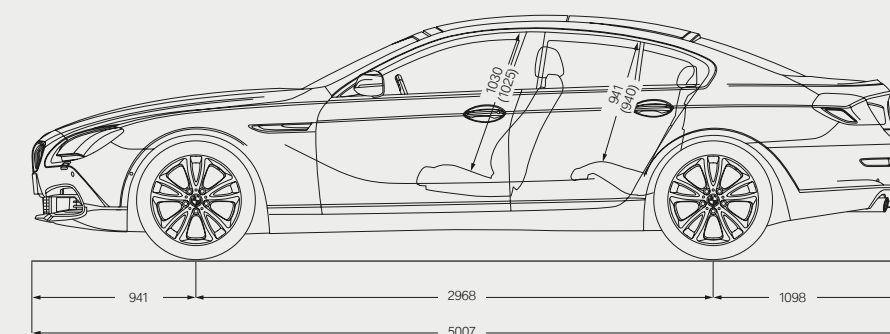
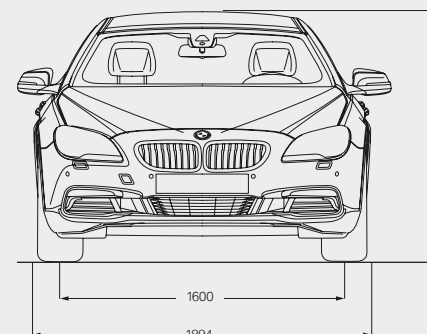

BMW 6 Series Coupé

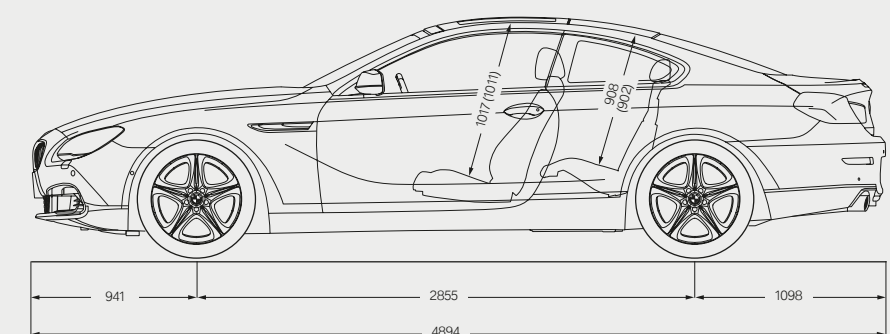
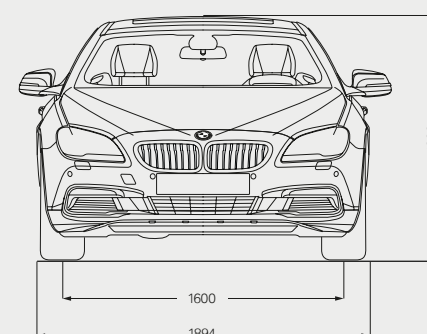

BMW 6 Series Convertible

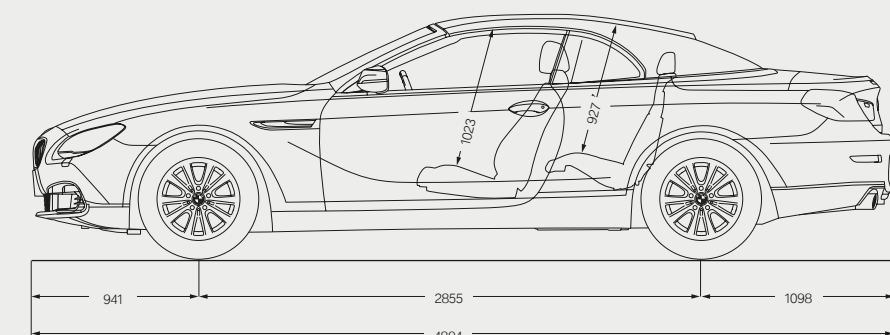
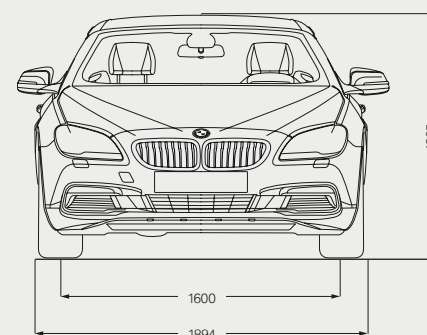

All drawing measurements in millimetres. Figures in () refer to vehicles with glass roof. Luggage compartment capacity: Gran Coupé, 460 litres; Coupé 460 litres; Convertible 300 to 350 litres (with raised soft top).

WELL TAKEN CARE OF WITH BMW SERVICES:

When you buy a BMW, you can look forward to superb service and comprehensive customer care. For example, the **Condition Based Service** independently tracks both service fluid levels and the condition of parts subject to wear and then notifies you in the display when the vehicle requires servicing. So you only need to go to your BMW service partner when it's really necessary. When you do go, our

qualified BMW service specialists take care of your vehicle using the newest workshop technology and only **original BMW parts**. This service is available worldwide in more than 3,300 BMW service partner establishments in over 150 countries, to provide you with limitless driving pleasure.

BMW SERVICE.



BMW Service Packages*: Individual and stress-free, just for you. Individual, well-thought-out servicing solutions carefully tailored to you and your vehicle. With one-off, predictable costs, BMW Service Packages give you complete peace of mind, so you can enjoy owning a BMW to the very fullest. Whether it's fresh from the showroom or already well-travelled – there's a BMW Service Package for every phase of your vehicle's life. All bringing you maximum quality, expertise and value retention, always at reasonable, transparent rates. And always carefully tailored to you and your BMW. Find out just how stress-free truly individual service can be!

www.bmw.com/serviceinclusive



BMW Mobile Service*: This service is there for you day and night. As soon as you call, we spring into action, and take care of everything that may need doing after an accident or breakdown, with specially trained technicians working – on site or via telephone – to get your car back on the road. We offer comprehensive, country-specific mobility packages for breakdowns, and insurance that covers you in the event of an accident or theft. So if anything untoward does happen, simply call up the BMW accident hotline and we'll go to work. We'll take care of calling the emergency services, a tow truck, a replacement car, notifying your insurance company and much more. For further information please visit www.bmw.com



BMW TeleServices*: With Condition Based Service, you'll be automatically reminded of your next necessary service appointment on the vehicle screen. Provided you've consented, key vehicle data will be relayed to BMW automatically for analysis. Your assigned BMW service partner will access the information and contact you free of charge to make a service appointment as and when necessary. To access BMW Teleservices, the vehicle must be equipped with the optional Intelligent Emergency Call or ConnectedDrive Services. The service can be deactivated at any time you so desire, and you can change your service partner in the iDrive menu or ConnectedDrive portal. Find out more at www.bmw.com/teleservices

BMW FINANCIAL SERVICE.



BMW Financial Services*: Mobility solutions to meet your needs. BMW Financial Services provides you with attractive leasing, finance and insurance options. To find out more, see the price list or go to www.bmwfs.com. Your BMW partner will also be glad to draw up an individual offer for you in person.

THE BMW EXPERIENCE.



BMW TV*: www.bmw.tv enables you to experience the BMW brand in all its diversity. Features, portraits and background reports provide you with information on automobiles, innovations, sports and lifestyle topics.



BMW Driving Experience: The better you control your BMW, the more enjoyment you will derive from driving it. Use our training courses to learn for yourself what it means to reach a car's physical limits on various types of surfaces, and what you have to do to control your vehicle even in extreme situations. For further information please visit www.bmwdrivingexperience.com



BMW Welt: Picking up a car at BMW Welt has always ranked among the best moments for any driver. Turn this moment into one whole unforgettable day: experience the handover of your new BMW as just one part of a programme of activities perfectly tailored to your interests. At BMW Welt, the BMW Group plant, the BMW Museum, the BMW Group headquarters and the BMW Group Classic all combine to provide you with a great experience of an exciting history, a breathtaking present – and spectacular visions for the future. Find out more at www.bmw-welt.com/en



BMW Magazine: In BMW Magazine, experience the newest BMW models in front of stunning backdrops. Discover new design trends, travel destinations and the richness of modern life. Encounter people with visionary ideas who are changing the world. Find out more at www.bmw.com/magazine

* May not be available in all countries. Please consult your BMW partner.

SHAPING THE FUTURE – RESPONSIBLY.

In 2015, the BMW Group was once more listed in the Dow Jones Sustainability Index as the most sustainable automotive company worldwide. This makes BMW Group the only company in the automotive industry to be listed without interruption since the index was established. The development of efficient vehicle concepts and environmentally friendly production processes, including recycling, is an integral part of our philosophy. BMW EfficientDynamics and electric vehicles have enabled us to cut CO₂ emissions from our European new-vehicle fleet by more than 40% since 1995. We have also reduced the amount of resources used in production, such as water and energy, by 34% between 2006 and 2015, with a reduction to 45% of previous levels aimed at for 2020. In terms of other resources (such as volatile organic compounds, process wastewater and waste) our 45% target was met in 2014, and we will continue to work on further improvement. Production at our engine plant in Steyr has been waste-water free since 2007. And of course, at the end of its service life, every one of our vehicles can be easily and economically recycled. To return your end-of-life vehicle, please contact your BMW partner. For more information on this issue please visit our website.

www.bmw.com/EfficientDynamics
www.bmwgroup.com/responsibility
www.bmw.com/recycling

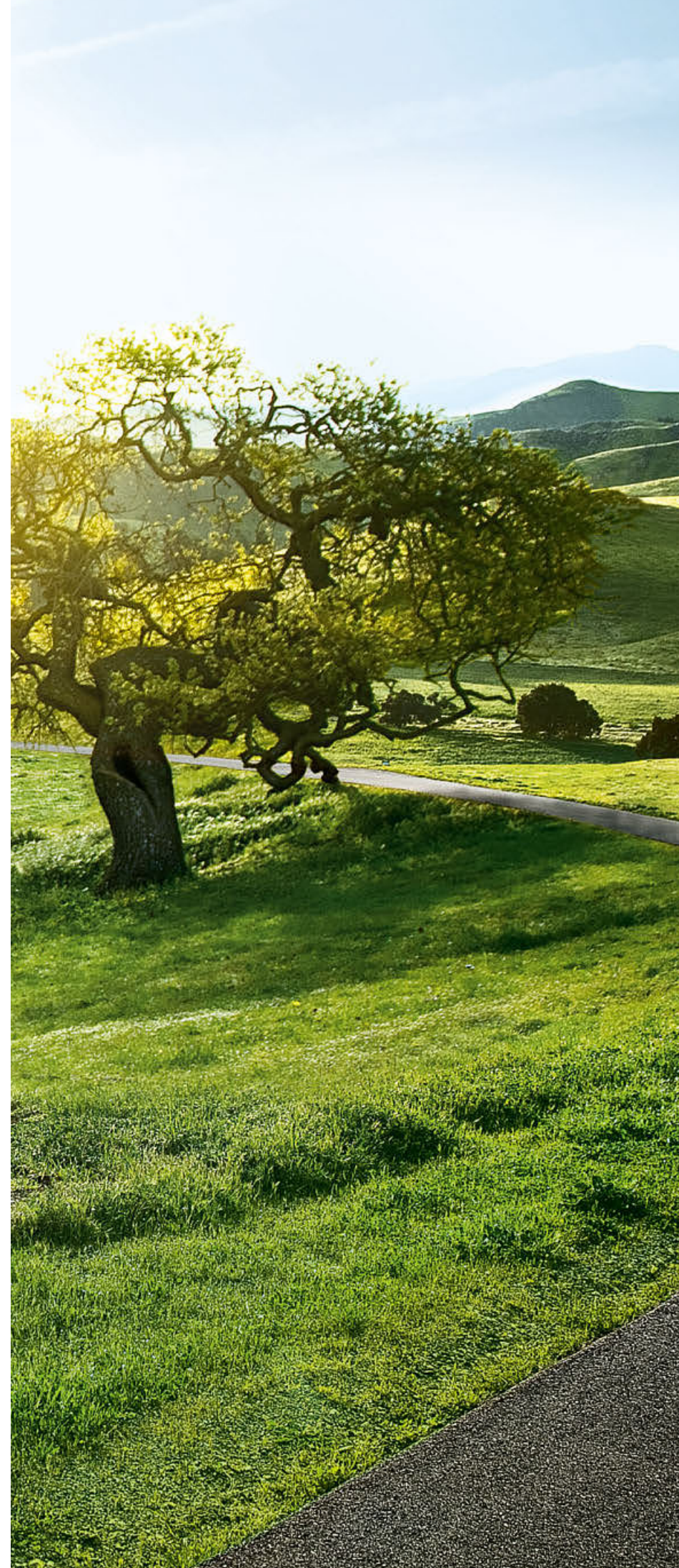

More about BMW



Sheer
Driving Pleasure

www.bmw.com



The models illustrated in this brochure show the specifications of vehicles produced by BMW AG for the German market. In part, they include optional equipment and accessories not fitted as standard. According to the specific requirements of other markets, alterations in models, standard and optional equipment, as described in this brochure, may occur. For more precise information about countryspecific vehicle versions, please contact your local BMW partner. Subject to change in design and equipment.

© BMW AG, Munich/Germany. Not to be reproduced wholly or in part without written permission of BMW AG, Munich.

4 11 006 231 202 2016 BM. Printed in Germany 2016.