

BMW 5 Series
Gran Turismo



Sheer
Driving Pleasure

www.bmw.com



THE BMW 5 SERIES GRAN TURISMO.

BMW EFFICIENT DYNAMICS.
LESS EMISSIONS. MORE DRIVING PLEASURE.

THE NEXT
100 YEARS





**FREEDOM
STARTS HERE.**



The BMW 5 Series Gran Turismo

DISCOVER FREEDOM.

- 06 Exterior design**
Unmistakably independent.
- 10 Versatility**
Flexible space. Winning ways.
- 12 Interior**
Generosity of space. Unique ambience.
- 18 Personal service**
Support for every journey.

Technology

INNOVATION ROOM.

- 22 BMW ConnectedDrive**
So connected, you're free.
- 26 BMW EfficientDynamics**
The technology package for reduced fuel consumption and emissions.
- 28 Engines**
Maximum performance, minimum fuel consumption.
- 30 Chassis and safety**
Innovative systems for more driving pleasure.

Equipment

AS INDIVIDUAL AS YOUR IMAGINATION.

- 34 BMW 5 Series Gran Turismo**
- 36 BMW Luxury Line**
- 38 M Sport package**
- 40 BMW Individual**
- 42 Colours, upholstery and interior trims**
- 48 Standard/Optional equipment**
- 59 Original BMW Accessories**

Overview

THE ENTIRE RANGE AT A GLANCE.

- 60 Technical data and information on fuel consumption and CO₂ emissions**
- 62 BMW Service**
BMW Service, BMW Financial Services and BMW Experience.

Editorial

DISCOVER FREEDOM. ENJOY THE MOMENT.

Driving can be so much more than the simple business of getting from A to B. This is why every BMW is so much more than a simple automobile. The BMW 5 Series Gran Turismo gives shape to this thinking more emphatically than ever. Unique in its class, this concept embodies the best that a vehicle can offer. In this way, it makes the experience of travel precisely what it should be – something special.

This is luxury and versatility that combines in a compellingly new, generously proportioned form. Timeless elegance meets the highest levels of comfort. Ground-breaking innovation offers unlimited possibilities. And wherever you may go in the BMW 5 Series Gran Turismo, one goal will always be reached – enjoyment of the moment.

www.bmw.com/5series

Equipment of the vehicle shown: BMW 535i Gran Turismo Luxury Line.

Engine:	BMW TwinPower Turbo inline six-cylinder petrol
Output:	225kW (306hp)
Wheels:	20" light alloy Multi-spoke 459
Exterior colour:	Kallisto Grey metallic
Upholstery:	Ivory White exclusive Nappa leather with exclusive stitching
Interior trim:	Fine-wood trim Ash Grain Brown with inlay



In 2016 the BMW brand will be celebrating its 100th anniversary. Find out more at www.next100.bmw

WHEN THE UNIQUE IS ALSO THE EXTRAORDINARY.

Sometimes, the most extraordinary combinations are the ones that hold the deepest attraction. The exterior lines of the BMW 5 Series Gran Turismo illustrate this point well. They evoke the stylish presence of a saloon and yet also the elegance of a coupé. This fusion of identities gives the BMW 5 Series Gran Turismo independent, unmistakable character. This is, indeed, an exceptional automobile – a unique BMW.





SPACE. IN PERFECT FORM.

The elongated powerdome. The short overhangs. The characteristic Hofmeister kink in the C-pillars. The BMW 5 Series Gran Turismo is, evidently, a typical BMW. Its roofline interprets Gran Turismo proportions in an elegant and contemporary new way, right through to the dynamic rear. Here, the tailgate and the lights with their flat look present an even sportier conclusion. Additionally, the optional Adaptive LED Headlights underscore the modern and purposeful impression given by the BMW 5 Series Gran Turismo – at every moment.



TAILOR-MADE FREEDOM.

The perfectly formed silhouette of the BMW 5 Series Gran Turismo is an impressive sight. Within it, there are equally impressive insights when it comes to versatility. It all adds up to a very special kind of convenience – the freedom to do exactly as you wish.





WHERE LAID BACK IS THE RIGHT ATTITUDE.

The elegance of the frameless doors hints immediately at what lies behind them: an interior that indulges all on board with stylish, crafted materials that reveal a genuine love of detail. The harmonious combination of the front and the rear gives the interior a feeling of incomparable roominess. Maximum comfort is also ensured in the rear thanks to seats that slide by 73 millimetres for remarkable legroom. The overall result is a refined, first-class atmosphere that invites you to savour every moment of every journey – even after you've arrived.



**LUXURY THAT
CREATES CLARITY.**

**AS DYNAMIC AS
EFFICIENCY GETS.**





PERSONAL SERVICE STARTS IN THE VEHICLE.

Wherever your travels may take you in the BMW 5 Series Gran Turismo, there will always be one central point of attention – you. Nothing illustrates this more clearly than the Concierge Service* from BMW ConnectedDrive: whether you need a restaurant recommendation, a hotel reservation or information on cultural attractions, simply call from the car and personal support is ready, around the clock, to answer your questions in your own language. Address details can also be sent directly to the navigation system. It all makes it even easier to discover new places and experience unforgettable moments in the BMW 5 Series Gran Turismo.

* May not be available in all countries. Please consult your BMW partner.

**GIVING MAGNITUDE
TO THE MOMENT.**



BMW ConnectedDrive So connected, you're free.



Every day our lives are becoming more and more connected. BMW drivers, however, enjoy better connections with the outside world than most. They can source information, communicate by telephone and email, keep an eye on the traffic and generally stay up to date while on the move. The services that so effectively network BMW vehicles with the outside world are grouped under one term – BMW ConnectedDrive¹.



BMW ConnectedDrive, with its intelligent services and assistance systems, is ready with all the right equipment. BMW ConnectedDrive Services & Apps offer more freedom by providing versatile connections between the driver, vehicle and the outside world. BMW ConnectedDrive Driver Assistance systems make driving a BMW safer and more comfortable. And intelligent systems make life easy for the driver and minimise the dangers of traffic.

For more information, go to:

➔ www.bmw.com/ConnectedDrive

CONNECTED DRIVE SERVICES.

The **ConnectedDrive Services*** option keeps you seamlessly connected with the people and the things that matter to you. And every function has been developed to enhance your driving experience. ConnectedDrive Services offers a comprehensive selection of services and apps, including Facebook, web radio and Message Dictation.



Choose the ConnectedDrive Services* option when you order your vehicle and you will benefit from a wealth of additional services – all easily accessible through the **BMW ConnectedDrive Store**. Here you can find information on individual offers, services and apps at any time and, as desired, book them directly in the vehicle. Alternatively, you can access them via the My BMW ConnectedDrive customer portal on your PC or tablet.

* May not be available in all countries. Please consult your BMW partner.

¹ For further information on BMW ConnectedDrive, please visit www.bmw.com/connecteddrive

The images shown have been last updated in May 2015.

BMW CONNECTED DRIVE SERVICES & APPS – INTELLIGENT CONNECTIVITY.

The **BMW ConnectedDrive Services & Apps*** – configuring them according to your individual needs is now quicker and easier than ever before. Want to listen to your favourite music on every journey? No problem with AUPEO! personal internet radio.



AUPEO! PERSONAL INTERNET RADIO – CREATE YOUR OWN RADIO PROGRAMME.

With a smartphone and the free AUPEO! personal internet radio app, you only hear the music you want to hear. Customisable internet radio adapts itself to your musical taste. Choose from over 120 music genres in a music library that currently comprises over one million songs. Use the “Love” and “Ban” buttons in the Control Display to define your musical preferences. The smartphone is connected to the car via the snap-in adapter or a cable recommended by BMW. This function requires the Navigation System Professional.



INTERNET – INFORMATION AT YOUR FINGERTIPS.

Whether you need to check the balance in your bank account, place a bid on eBay or look something up in Wikipedia, the BMW ConnectedDrive Internet option ensures that you can do whatever you need to do online. To enable you to surf to your heart's content, the iDrive Controller in the centre console doubles as a computer mouse.



BLUETOOTH OFFICE – ALWAYS IN TOUCH.

Bluetooth Office enables BMW office functions such as email, appointments, tasks, contacts and text messages to be shown on the Control Display or read out over the audio speakers using the text-to-speech function. All compatible mobile devices are listed at www.bmw.com/bluetooth.

BMW CONNECTED DRIVE DRIVER ASSISTANCE – A CO-DRIVER WHO THINKS AHEAD.

BMW ConnectedDrive Driver Assistance includes innovative functions that enhance safety and convenience, maximising your driving pleasure. Want to know if there's a sharp curve coming up? The full-colour BMW Head-Up Display will show you. How about more precise parking? The Parking Assistant will take care of it for you.



BMW HEAD-UP DISPLAY – KEEP YOUR FOCUS ON THE ROAD.

The full-colour BMW Head-Up Display¹ projects driving-relevant information directly into the driver's line of sight. In this way, focus can also be kept on the road ahead. It shows, for example, the current speed, navigation instructions, Speed Limit Info incl. no-overtaking indicator, Check-Control messages and infotainment.



DRIVING ASSISTANT PLUS – RELAX AND LEAVE THE ROAD TO YOUR BMW.

Driving Assistant Plus comprises not only Approach Control Warning and Lane Departure Warning but also Active Cruise Control with Stop&Go function and the Traffic Jam Assistant². In this way, Driving Assistant Plus considerably enhances safety and comfort when driving on motorways. The Navigation System Business or Professional and a Steptronic transmission are prerequisites for Driving Assistant Plus and the Traffic Jam Assistant.



PARKING ASSISTANT – A WELCOME TOUCH.

This optional driver assistance system makes parallel parking easier. When travelling at speeds below 35km/h, the system measures any parking gaps the vehicle passes. When a big enough gap has been found, the Parking Assistant will do the steering, while the driver continues to operate the accelerator and brake pedals – supported by acoustic signals and instructions in the Control Display.

* May not be available in all countries. Please consult your BMW partner.

¹ Visibility of the display is limited with polarised sunglasses.

² Not available for models with xDrive.

The images shown here are equipment examples. Features are individually specific to every BMW. Depending on the model, the Control Display and presentation of content may differ.



BMW EFFICIENT DYNAMICS.
LESS EMISSIONS. MORE DRIVING PLEASURE.

BMW EFFICIENT DYNAMICS – MAKING A LITTLE GO A LONG WAY.

For BMW, the focus is always on delivering quintessential BMW driving pleasure. The pioneering BMW EfficientDynamics strategy, used across the entire model range, supports this goal using innovative technologies that minimise the vehicles' fuel consumption and emissions while at the same time enhancing dynamic performance and driving enjoyment.

It's a comprehensive technology package that encompasses the engine, energy management and the vehicle concept – and is standard in every BMW.

The new generation of petrol and diesel engines in the BMW TwinPower Turbo family is responsible for the improved performance and the reduction in emissions. Optimised aerodynamics and BMW EfficientLightweight contribute to increased efficiency. The BMW intelligent lightweight construction concept is all about using the right material in the right place, in order to lower weight, increase rigidity and thus achieve maximum agility.

BMW is leading the charge in terms of innovation in this area and is the only major car manufacturer that uses ultralight and highly rigid carbon fibre (CFRP). BMW also focuses on forward-thinking drive train concepts such as the BMW eDrive technology with a 100% electric powerplant, as well as plug-in hybrid models.

Overall, the technology package encompasses a multitude of optimisation measures in every BMW. Other features such as the ECO PRO mode, the Automatic Start/Stop function, the optional eight-speed Steptronic transmission and Brake Energy Regeneration also contribute to reductions in fuel consumption and emissions. Included as standard in every BMW.

BMW EFFICIENT DYNAMICS INNOVATIONS IN THE BMW 5 SERIES GRAN TURISMO AT A GLANCE.

The **Automatic Start/Stop function** ensures that fuel is used only when the car needs it. When the car has been braked to a standstill and the engine is at idle, Automatic Start/Stop turns off the engine. This happens, for example, at traffic lights and start-stop traffic, thus increasing the fuel-savings potential.

BMW TwinPower Turbo technology combines the petrol engines with a TwinScroll turbocharger with Valvetronic, Double-VANOS and High Precision Injection. With the diesel engines, CommonRail direct injection combines a turbocharger (535d with two-stage turbocharging) with variable turbine geometry. These measures significantly reduce fuel consumption in all powerplants, while, at the same time, considerably increasing power across a wide speed range.

With **Brake Energy Regeneration**, the alternator generates electricity mainly when the driver lifts off the accelerator pedal or applies the brakes. The kinetic energy this develops is converted into electric power and fed into the battery.

Carefully optimised **aerodynamics measures** ensure an excellent drag coefficient and, therefore, a positive effect on overall efficiency. A host of features contribute. They include flat underbody panelling, the optimised design of the front apron and air intakes and airflow management measures in the wheelarches.

Fuel-consumption-friendly **ECO PRO mode** intelligently adapts accelerator pedal and gearbox responses while also moderating the heating/air conditioning systems. ECO PRO tips further improve fuel efficiency with suggestions that optimise driving behaviour with the bonus range function indicating how many extra kilometres have been gained in the process. The results, depending on driving style, can lead to reductions in fuel consumption by up to 20 per cent. An additional five per cent saving is possible through the Coasting function, Route-Ahead Assistant and, in conjunction with the Steptronic transmission and the Navigation System Professional, ECO PRO Route. The saving potential quoted relates to the findings of internal BMW studies.

The **Optimum Shift Indicator** recommends the most suitable gear for fuel-efficient driving. The system also recommends when to shift up or down and adapts to individual driving behaviour.

The **eight-speed Steptronic transmission** provides significantly higher gearshifting and driving comfort thanks to closely defined gear ratios and minimised changes in engine speed at each transition. This also leads to a perceptible increase in dynamism and reduced fuel consumption. Additionally, a gear lever allows manual shifts.

ENGINES WITH ALL THE RIGHT VALUES. FOR ACCELERATION – AND FUEL CONSUMPTION.

The petrol engines. The innovative BMW TwinPower Turbo petrol engines are central to the BMW EfficientDynamics strategy and have won a host of awards. They combine the latest fuel injection systems, fully variable power control and innovative turbocharging technology.

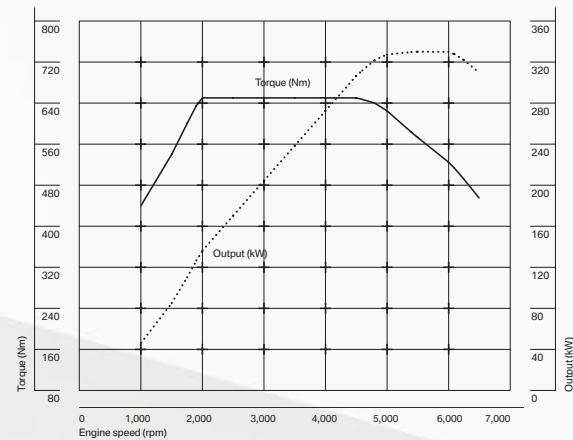

Impressive performance: the BMW TwinPower Turbo eight-cylinder petrol engine in the BMW 5 Series Gran Turismo 550i.

BMW 550i/550i xDrive.

The BMW TwinPower Turbo eight-cylinder 550i petrol engine with High Precision Injection delivers maximum torque of 650Nm from 2,000rpm and offers deep reserves of power for every situation. With 330kW (450hp), the powerful engine accelerates the new BMW 5 Series Gran Turismo from 0 to 100km/h in 5.0 seconds (550i xDrive: 4.8s). It is also efficient in its use of fuel, returning a combined 9.2–9.4l (550i xDrive: 9.6–9.9l) per 100km¹, while emitting just 214–220g/km¹ of CO₂ (550i xDrive: 224–230g/km¹).

BMW 535i/535i xDrive.

The BMW TwinPower Turbo inline six-cylinder 3.0-litre engine combines Valvetronic, Double-VANOS and High Precision Injection with a TwinScroll turbocharger. This intelligent innovation package reduces combined fuel consumption to just 8.2–8.5l (535i xDrive: 8.5–8.6l) per 100km¹ and leads to CO₂ emissions of 192–198g/km¹ (535i xDrive: 199–205g/km¹). The performance figures are also impressive: 225kW (306hp), max torque of 400Nm and acceleration from 0 to 100km/h in only 6.1s. Top speed is 250km/h (restricted).

The diesel engines. The BMW TwinPower Turbo technology in the diesel engines combines the latest fuel-injection technology and fully variable power control with innovative turbocharging for increased efficiency and greater dynamics. All are engineered in lightweight aluminium and come with a maintenance-free particle filter.

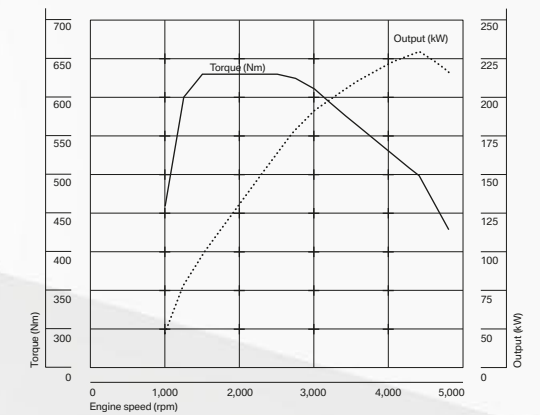

Peak torque of 630Nm is on tap between 1,500 and 2,500rpm. As a result, the BMW 535d reacts with impressive force to even light pressure on the accelerator pedal.

BMW 535d/535d xDrive.

The BMW TwinPower Turbo inline six-cylinder diesel engine, with its 3.0-litre capacity, combines CommonRail direct injection with two-stage turbocharging and variable turbine geometry. Even at low engine speeds, between 1,500 and 2,500rpm, it delivers its maximum torque of 630Nm. The smooth-running and highly responsive engine develops 230kW (313hp) and accelerates the BMW 535d from 0 to 100km/h in just 5.7 seconds (535d xDrive: 5.6s). Average fuel consumption is only 5.9–6.1 litres (535d xDrive: 6.4–6.6l) per 100km¹ and CO₂ emissions are a low average of 154–159g/km¹ (535d xDrive: 168–174g/km¹).

BMW 530d/530d xDrive.

This 3.0-litre BMW TwinPower Turbo inline six-cylinder diesel engine combines CommonRail direct injection and a turbocharger with variable turbine geometry. At just 1,500rpm, this engine, with its output of 190kW (258hp), is already delivering an impressive 560Nm of torque. The sprint from 0 to 100km/h takes 6.2s. Combined fuel consumption is only 5.8–6.0l (530d xDrive: 6.2–6.4l) per 100km¹ and CO₂ emissions are, on average, a low 153–159g/km¹ (530d xDrive: 163–169g/km¹).

BMW 520d.

The new BMW TwinPower Turbo four-cylinder diesel engine delivers powerful performance and high efficiency thanks to innovative technology: 135kW (184hp), 380Nm between 1,750 and 2,750rpm, 0 to 100km/h in 8.9 seconds, combined fuel consumption of 5.5–5.7 litres per 100km and CO₂ emissions of 144–149g/km¹.

¹ Fuel consumption and CO₂ emissions are dependent on wheel and tyre size. For more information, please see pages 60–61.



THE BEST PLATFORM FOR DRIVING DYNAMICS. AN OUTSTANDING CHASSIS.

A wide range of innovative technology in the BMW 5 Series Gran Turismo is there to make sure that you thoroughly enjoy every journey. Many systems are intelligently networked, allowing you to experience maximum driving pleasure in the utmost safety.



The **Adaptive Drive** option combines the active chassis control systems, Dynamic Drive and Dynamic Damper Control. Sensors constantly monitor speed and steering wheel angle as well as lateral and longitudinal acceleration of the vehicle. Based on this data, the stabiliser and shock absorber settings are regulated. This results in precise steering responses, shorter braking distances and, at the same time, increased ride comfort.

With **Dynamic Stability Control (DSC)**, sensors constantly monitor driving status and, as necessary, modify directional stability and traction by intervening in the engine and brake management systems. This makes it easier to handle the vehicle, even in difficult road conditions, and actively enhances driving safety and therefore driving pleasure.

The **Dynamic Damper Control** option allows the driver to ideally match the shock absorber characteristics to the driving situation. In addition to the standard COMFORT setting, there are two other programmes. With COMFORT+, the shock absorbers give a softer ride, reducing motion of the car to a minimum, especially on bumpy roads. In SPORT/SPORT+, the shock absorbers are automatically set to a firmer position, further increasing the driving enjoyment.

For rear-wheel drive vehicles, the optional **Integral Active Steering** system combines steering rear wheels with a variable steering-transmission ratio on the front axle. At up to 60km/h, the rear wheels steer in the opposite direction to the front wheels. This makes the wheelbase feel like it is shorter and thus improves manoeuvrability and agility. From about 60km/h, the rear wheels steer in the same direction as the front wheels. The resulting impression of a longer wheelbase enhances driving stability and comfort, which is particularly welcome when fast and abrupt lane changes are needed.

Passive safety. A comprehensive package of intelligent safety features in the BMW 5 Series Gran Turismo is specifically designed to minimise the risk of accidents – and provide the reassurance that you are always well protected. Extremely robust, high-volume support structures and the intelligent use of high-strength multi-phase steels ensure maximum strength of the passenger cell as well as low weight.

The standard **Driving Experience Control switch incl. ECO PRO** in the centre console allows you to select your desired mode at the touch of a button. In COMFORT mode,

the engine and transmission remain in their standard settings. ECO PRO mode is orientated towards efficiency. And SPORT mode puts the focus on even more dynamic driving.

The intelligent **BMW all-wheel system xDrive** adapts to even the most difficult road situations by always offering maximum possible traction. With xDrive and Dynamic Stability Control, your vehicle remains stable and on track. xDrive distributes power between the axles in fractions of a second for optimum roadholding.

The **eight-speed Steptronic transmission** provides significantly higher gearshifting and driving comfort thanks to closely defined gear ratios and minimised changes in engine speed at each transition. This also leads to a perceptible increase in dynamism and reduced fuel consumption. Additionally, a gear lever allows manual shifts.

MORE SAFETY. MORE DRIVING PLEASURE.

The BMW 5 Series Gran Turismo is full of cutting-edge technology that can always be relied on. Superb handling characteristics and innovative equipment come as standard, giving the driver exactly the right support for any situation. It all means that you can feel safe in all road conditions.

➔ www.bmw.com/5series

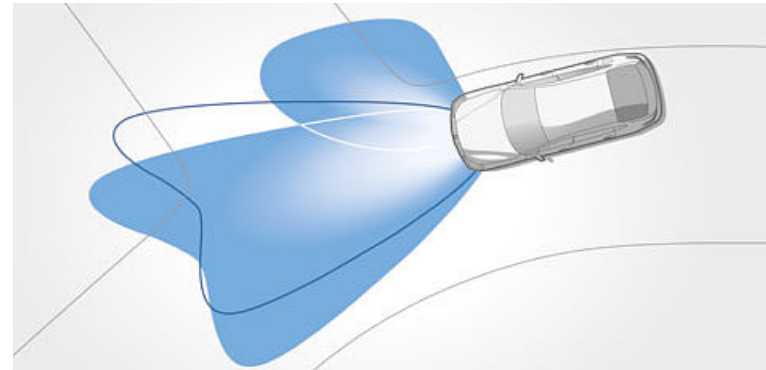

□ **Adaptive Headlights** with variable light distribution for city and motorway, including cornering lights, BMW Selective Beam (anti-dazzle High-Beam Assistant) with automatic full and dipped beam as well as Bi-Xenon technology provide optimum illumination of the road ahead. When driving at night, the adjustable headlights project their beam far into upcoming bends as the steering wheel is turned. The cornering lights are activated automatically by the steering angle or when the indicators are switched on, even when the car is stationary, thus also improving near-vision. In this way, the Adaptive Headlights ensure optimum illumination in every situation, greatly increasing active safety.

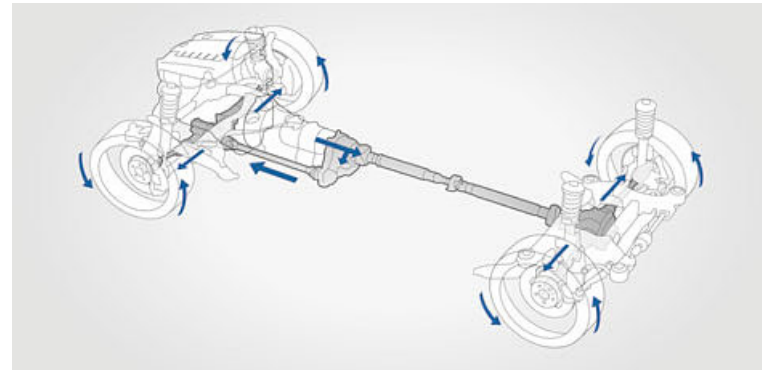

□ **BMW xDrive.** The intelligent all-wheel system distributes power continuously and variably to the front and rear wheels for increased traction, directional stability and driving safety in every situation.



■ **The BMW restraint system** is an essential passive safety feature in your vehicle. When there is a collision, the driver and front passenger belt latches are retracted in fractions of a second while the shoulder and lap belts are pyrotechnically tightened at the same time. The three-point seat belts, the belt tensioners and belt-force limiters function together systematically to ensure the most effective restraining effect.

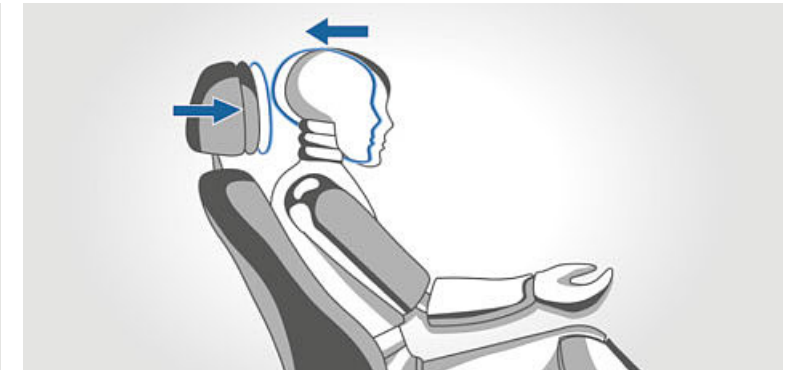

□ **Active front headrests** move towards to head to provide essential support in the event of a collision. In this way, they help to prevent overstretching of the cervical spine and minimise the risk of whiplash injury for the driver and front passenger (only in conjunction with Comfort seats).

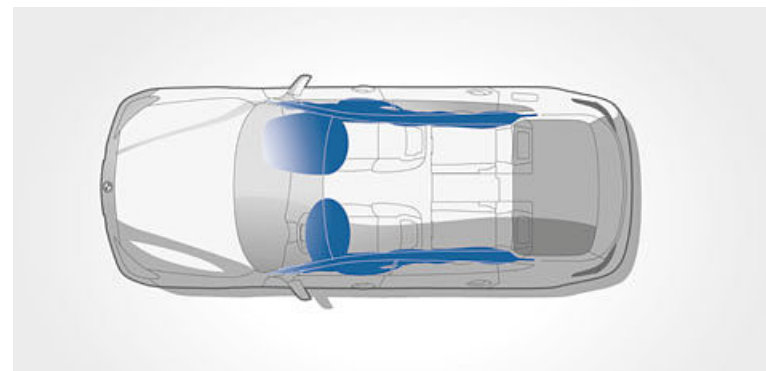

■ **Airbags** for the driver and front passenger are central, optimally coordinated safety features in every BMW. Six airbags provide targeted protection: driver and front passenger airbags, head airbags (curtain) front and rear and front seatback-integrated side airbags.

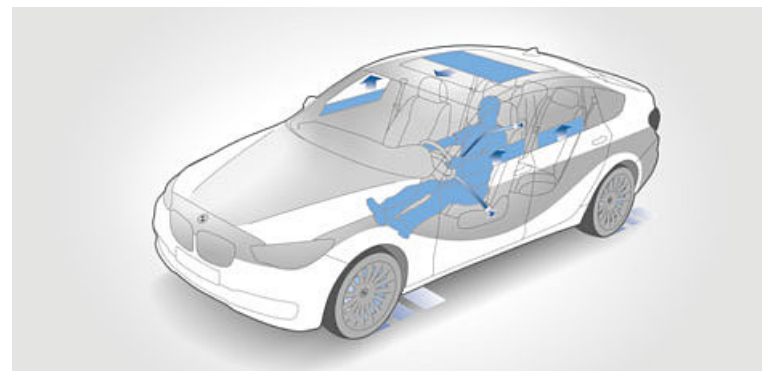

□ **Active Protection** is the preventative occupant protection system from BMW ConnectedDrive. In critical situations, for example, the safety belts are pre-tensioned, the seats are moved to an upright position and the windows are closed. Following an accident, the vehicle can also be automatically braked to a standstill. Additionally, Attention Assist monitors driving behaviour for signs of fatigue. The system analyses steering input and picks up on irregularities and responds with a recommendation to take a break shown in the Control Display.

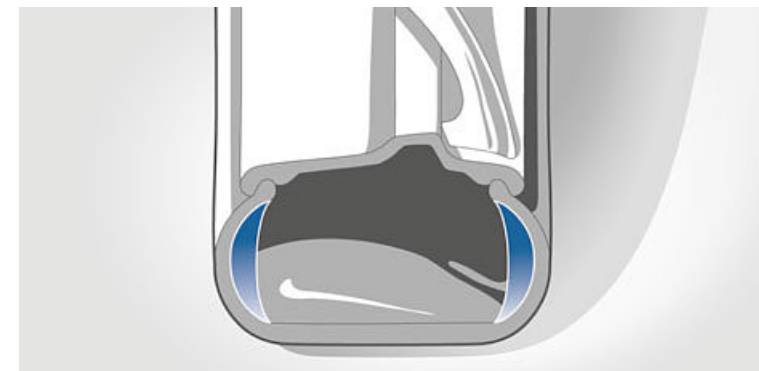

□ **Runflat tyres.** With reinforced sidewalls, the tyres do not collapse completely and remain on the rim, even if they have lost all of their air. This means that, in the event of a flat tyre, you can get your BMW safely to the nearest workshop.

■ **The Tyre Pressure Display** keeps the driver informed of pressure loss by means of a sensor. The air temperature is also monitored.

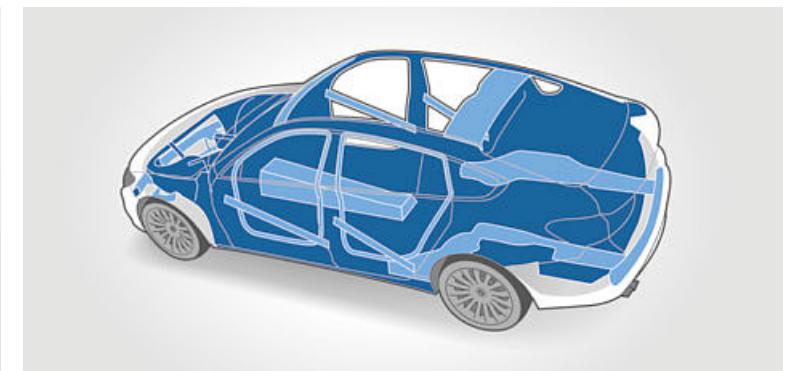

■ **Passenger cell.** Thanks to the directions of the beams and node joints and selective use of high-strength materials, this functionally designed structure provides maximum passive safety in the event of front, side or rear impact.

THE BMW 5 SERIES GRAN TURISMO.



The cockpit with its centre console inclined towards the driver demonstrates typical BMW driver orientation. The Radio Professional and 6.5" flat-screen colour display are already included as standard, as is the multifunction leather

steering wheel for excellent grip. Automatic, four-zone climate control, available on request (standard with 550i, 550i xDrive, 535d and 535d xDrive), as well as superb craftsmanship further enhance the sense of well being.



The above picture shows seats in Black Dakota leather and the optional Ash Grain fine-wood interior trim (standard for 550i and 550i xDrive). The BMW 5 Series Gran Turismo offers, as standard, plenty of storage, including two cupholders in the centre console.



The BMW 5 Series Gran Turismo is equipped as standard with, depending on the engine, 18" light alloy wheels Double-spoke 234 (pictured above: standard for 528i, 535i, 535i xDrive, 520d as well as 530d, 530d xDrive, 535d and 535d xDrive) or 19" light alloy wheels Star-spoke 272 with mixed tyres (standard for 550i and 550i xDrive).



THE BMW 5 SERIES GRAN TURISMO LUXURY LINE.

Interior equipment:

- Doorsill trims, front and rear, illuminated, with aluminium inserts and BMW logo
- Seats in Black, Veneto Beige or Ivory White Dakota leather, each with exclusive stitching and in Black or Cinnamon Brown Dakota leather each without exclusive stitching
- Seats in Black, Mocha or Ivory White exclusive Nappa leather, each with exclusive stitching
- Interior trim in fine-wood Finition Anthracite
- Interior trim in fine-wood Ash Grain Brown with inlay
- Ash Grain interior trim¹
- Satin Silver, matt, interior trim
- Interior trim in fine-wood Finition, light
- Sport leather steering wheel
- M leather multifunction steering wheel
- Keyfob with chrome insert
- BMW Individual extended fine-grain Merino leather

Exterior equipment:

- 19" light alloy wheels Multi-spoke 458
- 20" light alloy wheels Multi-spoke 459 with mixed tyres
- Tailgate trim strip in chrome
- Front bumper with chrome trim elements
- BMW kidney grille with chrome-look vertical bars
- Luxury logo on the side
- Illuminated door handles with chrome inserts
- Tailpipes in chrome
- Window recess covers and window frame trim in chrome, front and rear
- LED foglights

BMW Individual:

The features available from BMW Individual perfectly complement the Luxury Line (see pages 40/41).

¹ Standard for 550i and 550i xDrive.



The seats in Ivory White Dakota leather with exclusive stitching give the interior an exceptionally refined appearance.



■ Luxury logo on the side.



■ Sport leather steering wheel, three-spoke, with multifunction buttons and chrome trim.



■ 19" light alloy wheels Multi-spoke, 458 with mixed tyres. Front: 8.5 J x 19 with 245/45 R 19 tyres. Rear: 9.5 J x 19 with 275/40 R 19 tyres.



□ 20" light alloy wheels Multi-spoke 459 with mixed tyres. Front: 8.5 J x 20 with 245/40 R 20 tyres. Rear: 10 J x 20 with 275/35 R 20 tyres.



THE BMW 5 SERIES GRAN TURISMO M SPORT PACKAGE.

Interior equipment:

- M doorsill finishers
- M leather multifunction steering wheel
- Sport seats in Dakota leather with exclusive stitching
- Comfort seats for driver and front passenger as standard in Dakota leather with exclusive stitching
- Comfort seats in exclusive Black Nappa leather with exclusive stitching
- Comfort seats in extended BMW Individual leather
- Interior trim in Palladium Grey
- Interior trim in fine-wood Ash Grain¹
- Interior trim in fine-wood Ash Grain Brown with inlay
- Interior trim in fine-wood Finition Anthracite
- Interior trim in fine-wood Finition light
- M footrests
- BMW Individual Anthracite roofliner

¹ Standard for 550i and 550i xDrive.

Exterior equipment:

- 19" M light alloy wheels V-spoke 302 M with mixed tyres
- 20" M light alloy wheels Double-spoke 303 M with mixed tyres
- M Aerodynamics package (front apron with larger air inlets, side sills with additional lighting edge, rear apron with diffuser insert in Dark Shadow metallic)
- BMW Individual high-gloss Shadow Line
- Dark chrome tailpipes
- M Sport chassis, also with standard chassis on request
- "M" logo on side

BMW Individual:

The features available from BMW Individual perfectly complement the M Sport package (see pages 40/41).



Athletic interior design with the sporty M leather steering wheel and Sport seats in Black Dakota leather with exclusive stitching.



■ "M" logo on the side.



■ 19" M light alloy wheels V-spoke 302 M with mixed tyres. Front: 8.5 J x 19 with 245/45 R 19 tyres. Rear: 9.5 J x 19 with 275/40 R 19 tyres.



□ 20" M light alloy wheels Double-spoke 303 M with mixed tyres. Front: 8.5 J x 20 with 245/40 R 20 tyres. Rear: 10 J x 20 with 275/35 R 20 tyres.



powered by 

38 39 M Sport package

■ Standard M Sport package equipment

□ Optional M Sport package equipment

The BMW 550i Gran Turismo M Sport package in the optional exterior colour Carbon Black metallic.

BMW Individual

The expression of personality.



BMW Individual paint finish
Champagne Quartz metallic.



The BMW 5 Series Gran Turismo. Inspired by BMW Individual.

□ Driving a BMW is, in itself, a mark of character. There are those who still, however, want their vehicles to be even more individual reflections of their personality. The BMW Individual Collection and the BMW Individual Manufaktur meet these needs by opening up seemingly limitless opportunities for differentiation.

Precisely in tune with each model, the BMW Individual Collection offers a highly exclusive selection of equipment options. Fascinating paint finishes either refracting the light or with a matt effect. Leather, unique in colour and scope of application, perfected with clever contrasts and decorative stitching. Interior trims in the most exclusive fine woods, the immaculate Piano finish and the finest leather.

And yet even this can be surpassed – thanks to the BMW Individual Manufaktur. Here, there is only one goal: realising almost any customer request, even the most personal, with stylish, hand-crafted perfection.



BMW Individual fine-grain Merino leather Platinum
with exclusive piping in Black.



BMW Individual extended fine-grain Merino leather in Platinum
with exclusive piping in Black and leather-covered interior trim in Platinum.



EXTERIOR COLOURS.

M SPORT PACKAGE.



■ **Non-metallic 668 Black**¹



□ **Metallic A52 Space Grey**¹



□ **Metallic A83 Glacier Silver**¹

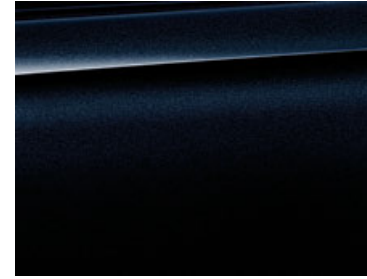

□ **Metallic 416 Carbon Black**



□ **Non-metallic 300 Alpine White**



□ **Metallic A90 Sophisto Grey, brilliant effect**¹



□ **Metallic B64 Kallisto Grey**



□ **Metallic 475 Black Sapphire**



□ **Metallic A89 Imperial Blue, brilliant effect**¹



□ **Metallic B65 Jatoba**



□ **Metallic A72 Cashmere Silver**



□ **Metallic B03 Damask Red**



□ **Metallic A96 Mineral White**

BMW INDIVIDUAL.



□ **BMW Individual X11 Frozen Bronze metallic**¹



□ **BMW Individual 490 Pure metal Silver**¹



□ **BMW Individual 490 Frozen Grey metallic**¹

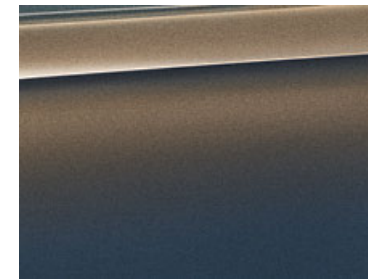

□ **BMW Individual X08 Champagne Quartz metallic**¹



□ **BMW Individual 490 Frozen Cashmere Silver metallic**¹



□ **BMW Individual 490 Frozen Dark Blue metallic**¹



□ **BMW Individual X02 Citrine Black metallic**¹



□ **BMW Individual 490 Frozen Silver metallic**¹

¹ Optionally available for the M Sport Package.

These pages show the colours and materials available for the BMW 5 Gran Turismo. Use them to identify your favourite colours or compare various combinations. These colour samples are meant to give a first impression of paints and materials. Experience has shown, however, that printed versions of paint, upholstery colours and interior trims cannot in all cases faithfully reproduce the appearance of the originals. We therefore recommend that you consult your BMW partner on your preferred colour choices. They will be happy to show you samples and assist with special requests.

BASE.

UPHOLSTERY COLOURS.

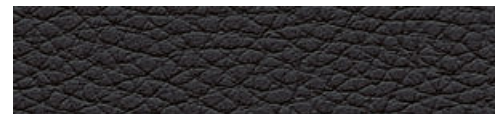

■ Dakota leather LCSW Black

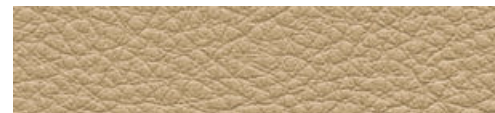

■ Dakota leather LCDF Veneto Beige

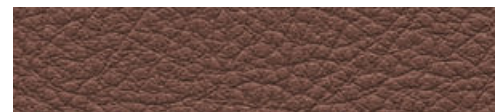

■ Dakota leather LCEZ Cinnamon Brown

INTERIOR TRIMS.



■ 4CG Satin Silver, matt



□ 4BN Fine-wood trim Ash Grain Brown¹

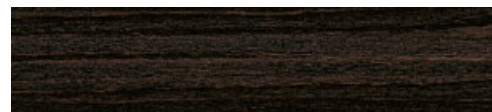

□ 4CE Fine-wood trim Finline, Anthracite

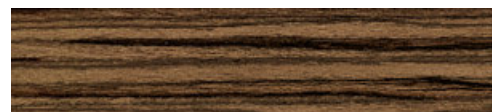

□ 4CK Fine-wood trim Finline, light

INTERIOR COLOURS.



Black



Veneto Beige

BMW INDIVIDUAL.

UPHOLSTERY COLOURS.



□ BMW Individual fine-grain Merino leather ZAC8 Platinum^{2,3} with exclusive piping in Black



□ BMW Individual fine-grain Merino leather ZAP5 Amaro Brown^{2,3} with exclusive piping in Black

INTERIOR TRIMS.



□ BMW Individual leather-covered interior trim XE9 to ZAC8 Platinum

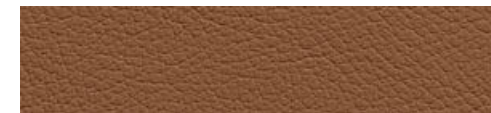

□ BMW Individual leather-covered interior trim XE9 to ZAP5 Amaro Brown

ROOFLINER.



□ BMW Individual roofliner 775 Anthracite

Please note that over time even correct use can lead to unrecoverable upholstery damage. This can be caused in particular by non-colourfast clothing.

¹ Standard for 550i and 550i xDrive.

² BMW Individual extended fine-grain Merino leather includes front and rear seats plus headrests, front seat backrests, armrest sides front and rear and centre console including armrest.

³ Only in conjunction with Comfort seats, front.

LUXURY LINE.

UPHOLSTERY COLOURS.

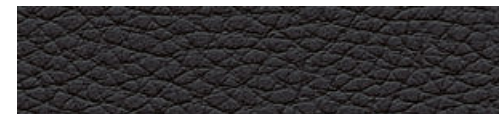

■ Dakota leather LCSW Black

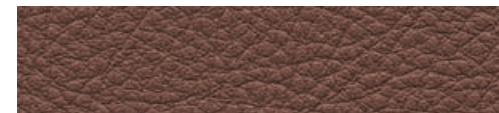

■ Dakota leather LCEZ Cinnamon Brown



■ Dakota leather LCLY Veneto Beige with exclusive stitching

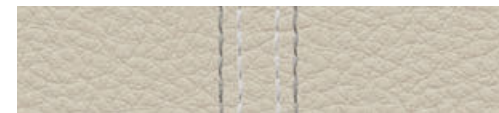

■ Dakota leather LCET Ivory White with exclusive stitching

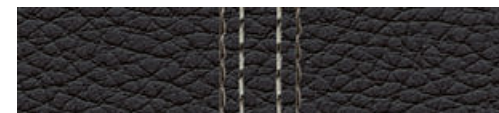

■ Dakota leather LCLZ Black with exclusive stitching



□ Exclusive Nappa leather LZMW Mocha with exclusive stitching



□ Exclusive Nappa leather LZET Ivory White with exclusive stitching

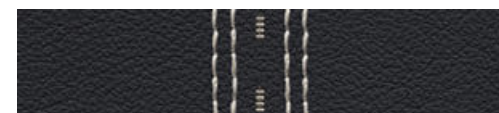

□ Exclusive Nappa leather LZLZ Black with exclusive stitching

INTERIOR TRIMS.

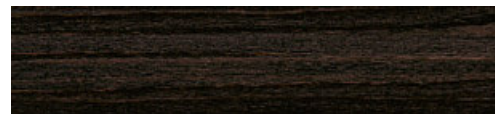

■ 4CE Fine-wood trim Finesline Anthracite



□ 4CK Fine-wood trim Finesline, light



□ 4BN Fine-wood trim Ash Grain Brown¹



□ 4CT Fine-wood trim Ash Grain Brown, with inlay



□ 4EK Satin Silver, matt, in combination with Lines

INTERIOR COLOURS.



Black



Veneto Beige

M SPORT PACKAGE.

UPHOLSTERY COLOURS.

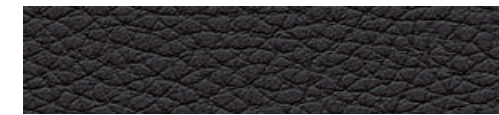

■ Dakota leather LCSW Black

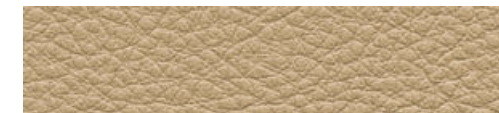

■ Dakota leather LCDF Veneto Beige

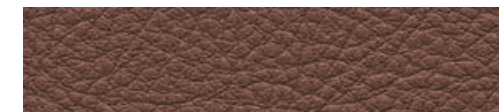

■ Dakota leather LCEZ Cinnamon Brown



■ Dakota leather LCLY Veneto Beige with exclusive stitching

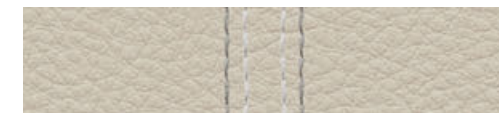

■ Dakota leather LCET Ivory White with exclusive stitching

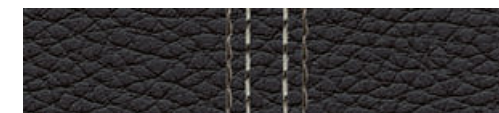

■ Dakota leather LCLZ Black with exclusive stitching



□ Exclusive Nappa leather LZMW Mocha with exclusive stitching



□ Exclusive Nappa leather LZET Ivory White with exclusive stitching

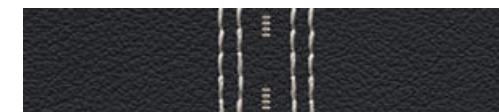

□ Exclusive Nappa leather LZLZ Black with exclusive stitching

INTERIOR TRIMS.



■ 4L7 Palladium Grey

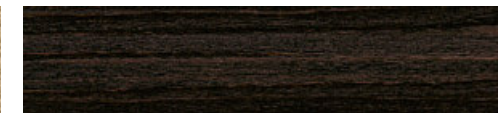

□ 4CE Fine-wood trim Finesline, Anthracite

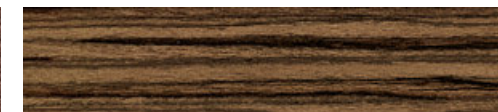

□ 4CK Fine-wood trim Finesline, light



□ 4BN Fine-wood trim Ash Grain Brown¹



□ 4CT Fine-wood trim Ash Grain Brown, with inlay

INTERIOR COLOURS.



Black



Veneto Beige

¹ Standard for 550i and 550i xDrive.

Standard / Optional equipment.



■ **Xenon Headlights** for high and low beam, including headlight washing system, accent lights and side indicators with LED technology, automatic headlight range control as well as parking, standing and daytime-running lights using four LED light rings.



□ **Adaptive LED Headlights** with BMW Selective Beam (anti-dazzle High-Beam Assistant), cornering lights and adaptive lights. Their bright colour approximates daylight for optimum illumination of the road, improved visibility and reduced tiredness when driving at night. The four LED light rings present an unmistakable look.



■ **The headlight washing system** ensures optimal illumination in all weathers. Headlights are automatically cleaned in parallel with the windscreen when the windscreen wash function is activated.



□ **LED foglights** harmoniously complement the colour of the LED or Xenon headlights. The bright white light also increases safety when visibility is poor.



■ **Wing mirrors** painted in body colour, electrically adjustable, aspheric and incorporating turn indicators with LED technology.



□ **BMW Individual high-gloss Shadow Line** with numerous details in high-gloss black: front and rear side window trim, window recess covers front and rear, window guides on the rear doors and wing mirror frames.



■ **Exterior features in body colour** including bumpers, door handles and roof mouldings.



□ **Soft-close automatic** gently pulls the doors shut.



□ **Panorama glass roof**, electric, with front slide and tilt function, sun blind, wind deflector and comfort opening via the vehicle key.



■ **Rain sensor** incl. automatic headlight activation ensures optimum visibility in the rain and the onset of darkness. The interval speed of the windscreen wipers is regulated according to rain intensity and, when needed, the low beam comes on automatically.



■ **Tailpipes with chrome look.** The 550i and 550i xDrive models are fitted with a trapezoid-shaped single tailpipe, left and right (shown here with dark chrome trim from M Sport package).



■ **Tailpipes with chrome look.** The 520d, 530d and 530d xDrive models are equipped with a visible double tailpipe on the left. The 535i, 535i xDrive, 535d and 535d xDrive have a single tailpipe left and right (pictured above).

Standard / Optional equipment.



■ **18" light alloy wheels Double-spoke 234**, 8 J x 18 with 245/50 R 18 tyres (standard for 535i, 535i xDrive, 520d, 530d, 530d xDrive, 535d and 535d xDrive).



□ **18" light alloy wheels V-spoke 425**, 8 J x 18 with 245/50 R 18 tyres.



□ **19" light alloy wheels Turbine Styling 452** in Bicolour Ferric Grey with mixed tyres. Front: 8.5 J x 19 with 245/45 R 19 tyres. Rear: 9.5 J x 19 with 275/40 R 19 tyres.



□ **19" light alloy wheels Multi-spoke 235** with mixed tyres. Front: 8.5 J x 19 with 245/45 R 19 tyres. Rear: 9.5 J x 19 with 275/40 R 19 tyres.



□ **19" light alloy wheels Star-spoke 272** with mixed tyres. Front: 8.5 J x 19 with 245/45 R 19 tyres. Rear: 9.5 J x 19 with 275/40 R 19 tyres (standard for 550i and 550i xDrive).



□ **20" light alloy wheels Turbine Styling 457** in Bicolour Ferric Grey with mixed tyres. Front: 8.5 J x 20 with 245/40 R 20 tyres. Rear: 10 J x 20 with 275/35 R 20 tyres.



□ **20" light alloy wheels Double-spoke 253** with mixed tyres. Front: 8.5 J x 20 with 245/40 R 20 tyres. Rear: 10 J x 20 with 275/35 R 20 tyres.

Luxury Line.



■ **19" light alloy wheels Multi-spoke 458** with mixed tyres. Front: 8.5 J x 19 with 245/45 R 19 tyres. Rear: 9.5 J x 19 with 275/40 R 19 tyres.



□ **20" light alloy wheels Multi-spoke 459** with mixed tyres. Front: 8.5 J x 20 with 245/40 R 20 tyres. Rear: 10 J x 20 with 275/35 R 20 tyres.

M Sport package.



■ **20" M light alloy wheels Double-spoke 303 M** with mixed tyres. Front: 8.5 J x 20 with 245/40 R 20 tyres. Rear: 10 J x 20 with 275/35 R 20 tyres.



■ **19" M light alloy wheels V-spoke 302 M** with mixed tyres. Front: 8.5 J x 19 with 245/45 R 19 tyres. Rear: 9.5 J x 19 with 275/40 R 19 tyres.

BMW Individual.



□ **20" BMW Individual light alloy wheels V-spoke 301 I** with mixed tyres. Front: 8.5 J x 20 with 245/40 R 20 tyres. Rear: 10 J x 20 with 275/35 R 20 tyres.

Standard / Optional equipment.



■ **Leather steering wheel**, three-spoke, multifunction.



□ **M leather multifunction steering wheel** incl. larger thumbrests and a thicker rim for extra grip as well as a more sporty look.



□ **Sport leather multifunction steering wheel**, three-spoke and with chrome inserts.



□ **Sport leather steering wheel with gearshift paddles**. Gears can be changed manually using the paddles mounted on the steering wheel (only in conjunction with Steptronic transmission with gearshift paddles).



□ **M leather steering wheel with gearshift paddles**. Gears can be changed manually using the paddles mounted on the steering wheel (only in conjunction with Steptronic transmission with gearshift paddles).



■ **Eight-speed Steptronic transmission** for significantly faster shift speeds and driving comfort thanks to closely defined gear ratios and smooth transitions. Along with the increase in comfort and dynamism, fuel consumption is also reduced. Additionally, manual shifts can be made via the gearlever.



■ **Driving Experience Control switch incl. ECO PRO**. This allows you to select your desired mode at the press of a switch in the centre console. In COMFORT mode, the engine and transmission remain in their standard settings. ECO PRO mode is orientated towards efficiency. SPORT mode puts the focus on even more dynamic driving. The active setting is shown beneath the speedometer.



■ **Standard seats** for driver and front passenger offer electric adjustment of seat height and backrest angle. The seat angle of the driver's seat is also electrically adjustable. Fore and aft seat positioning and headrest heights are manually adjustable.



□ **Comfort seats** for driver and front passenger incl. active headrests and multiple electrical adjustment. The upper backrest, backrest width, thigh support and headrest height can all be individually configured. Lumbar support and memory function for driver and front passenger are also included.



■ **Centre armrest, rear**, foldable, with storage compartment.



■ **Rear seats**, for travel in comfort. The seatbacks incline to a comfort position.



□ **Sport seats** for driver and front passenger offer optimum lateral support. Seat height, backrest and seat angle are electrically adjustable. Thigh support is manually adjustable.



□ **Ambient lighting** provides illumination in areas including the front centre console, all door pockets and door panels, door openers, doorsills (not illuminated with M Sport package), door exit areas and the exterior door handles. A colour switch function allows a choice between a brighter white or a muted orange light (standard for 550i and 550i xDrive).

Standard / Optional equipment.



□ **Driving Assistant** combines the Lane Departure Warning and Approach Warning systems. The Approach and Pedestrian Warning with City Brake Activation issues a warning between 10 and 60km/h if there is a risk of collision with vehicles or pedestrians and brakes the vehicle in the event of an emergency. From speeds of approx. 70km/h, Lane Departure Warning alerts the driver to an unintentional lane change via slight vibration in the steering wheel.



□ **Driving Assistant Plus** with Approach Control Warning and Lane Departure Warning plus Active Cruise Control with the Stop&Go function and Traffic-queue assistance (not available for models with xDrive). With these features, Driving Assistant Plus increases safety and comfort in motorway driving. Navigation System Business or Professional required for use.



□ **BMW Night Vision with Dynamic Light Spot** using a thermal camera, captures and transfers images of people and animals up to a distance of 300 metres directly into the Control Display. The system also detects people and larger animals at greater distances, illuminates them and provides an acoustic signal and a warning display in the instrument cluster.



□ **Lane Change Warning.** When the indicator is activated to signal the intention to change lanes, at speeds from 50km/h, this system detects a vehicle in the driver's blind spot or approaching in the overtaking lane. It then warns the driver with steering wheel vibration and a visual signal in the wing mirror housing.



□ **Speed Limit Info** shows speed limits and information on overtaking restrictions in the Info Display or the BMW Head-Up Display.



■ **ECO PRO mode** can, depending on individual driving style, reduce fuel consumption by up to 20 per cent (determined in internal BMW fuel consumption evaluation). An additional five per cent of savings can be gained with the Coasting feature, Route-Ahead Assistant and ECO PRO Route, in conjunction with the Navigation system Professional.



□ **Active Protection** comprises a number of vehicle safety features. In a critical situation, for example, the safety belts are pre-tensioned, the seats are moved to an upright position and the windows are closed. Following an accident, the vehicle can also be automatically braked to a standstill. Additionally, Attention Assist monitors the driver's steering input and responds with appropriate recommendations in the Control Display.



■ **Instrument cluster with extended functionality** including, among other features, a high-resolution Info Display for showing Check Control and other messages, navigation instructions as well as titles and source information for music tracks being played and telephone redial lists. When ECO PRO mode is active, graphics in the instrument cluster and ECO PRO tips encourage a more efficient driving style.



□ **BMW Head-Up Display, full colour,** projects driving-relevant information directly into the driver's field of vision (recognition limited by polarised sunglasses). In this way, focus always remains on the road ahead. Information shown includes current speed, navigation instructions, Speed Limit Info incl. no-overtaking indicator, Check Control messages and infotainment.

□ **Multifunctional Instrument Display** with Black Panel technology and a 10.2" diagonal screen offers an impressive visual representation of the driving experience. Three different modes and their specific characteristics, adapted with colour and graphics, can be displayed in the instrument cluster. The modes are: COMFORT, SPORT and ECO PRO.



□ **Surround View** comprises the Rear View camera with Top View and Side View to offer a panoramic 270-degree perspective. Top View monitors areas by the doors and to the sides of the vehicle for easy manoeuvring. Side View provides an early view of cross-traffic at blind junctions or exits. In each case, images are shown in the Control Display.



□ **Park Assistant** makes parallel parking easier. At low speeds, the system measures parking spaces that the vehicle passes. When a large enough space is found, Park Assistant takes over the steering while the driver controls the manoeuvre through gear selection and operation of the accelerator and brake pedals.

Standard / Optional equipment.



■ **iDrive Controller**, within easy reach in the centre console, allows intuitive operation of all integrated iDrive functions via the Control Display.
 □ **Ceramic application** for control functions include, for example, the gear lever, the front Controller surround as well as volume and temperature controls. For a high-quality and unique impression.



□ **Automatic air-conditioning with four-zone regulation**, equipped as automatic air-conditioning with two-zone regulation but with additional air vents in the B-pillars as well as a comfort vent in the centre of the instrument panel for directional or draft-free ventilation. Additionally, the outer rear seats feature individual temperature control complete with display (standard for 550i, 550i xDrive, 535d and 535d xDrive).



■ **Automatic air-conditioning with two-zone regulation** allows independent, automatic temperature control for the driver and front passenger. Includes rear-seat vents, microfilter, fogging sensor, Max-Cool button and park ventilation function.



□ **Navigation System Business**, Radio Professional, CD drive and a fixed 6.5" LCD colour monitor. Route guidance is provided by arrow/map display and spoken instruction.



□ **Navigation System Professional (new generation)** with high-resolution 10.2" colour display, incl. DVD drive, integrated hard disk for storage of audio files transferred from CDs, MP3 players or USB sticks, as well as dynamic route planning, RTTI-compatible, 3D route map, ECO PRO Route and split-screen function.



□ **Bang & Olufsen high-end Surround Sound system** includes 16 loudspeakers with 1,200 watts of music power. Dirac Dimensions signal process also helps ensure outstanding acoustics. Two sound options are featured, Studio and Expanded, along with special lighting effects for the individual speaker frames.



■ **Radio BMW Professional**, incl. 6.5" colour monitor, iDrive Controller with one-touch buttons, CD drive and MP3 decoder.
 □ **DAB tuner** (Digital Audio Broadcasting) offers a wider selection of stations, including many themed stations, in perfect sound quality across the entire transmission range thanks to digital reception. DAB+ enabled.



□ **Harman Kardon Surround Sound system** with a powerful 600-watt digital amplifier, vehicle-specific equalising, 16 loudspeakers incl. centre speaker, DIRAC signal processing and surround mode creates an aural experience of the highest intensity. An aluminium signature in each of the mirror triangles is also featured.

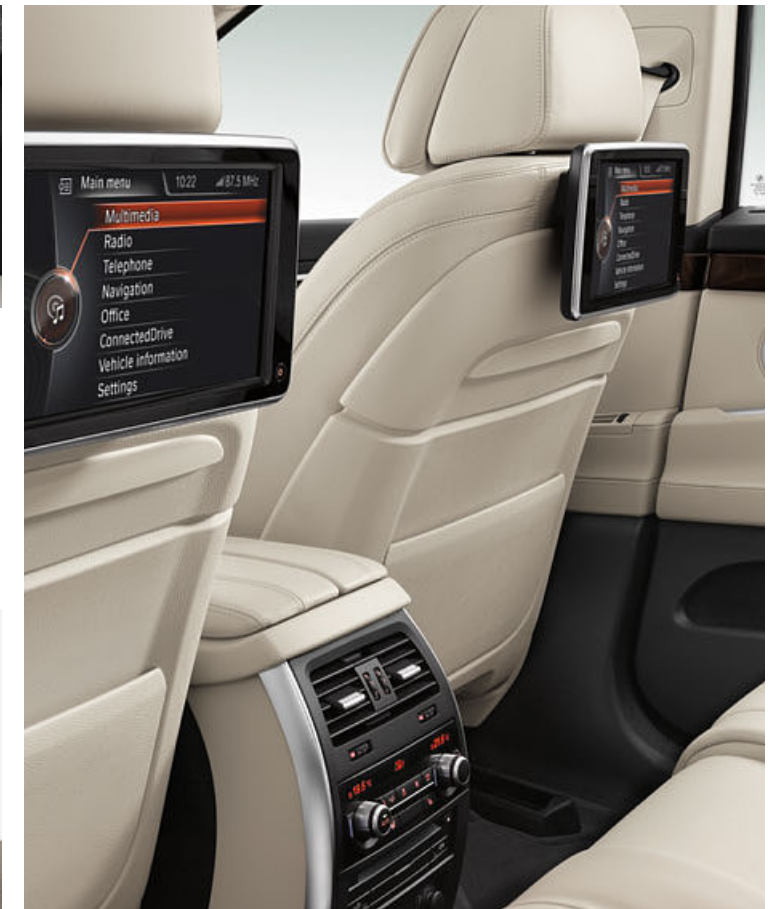

□ **Rear Entertainment Professional**, with two separate 9.2" colour displays (adjustable by angle) and a DVD drive, allows navigation and use of the internet (with mobile phone contract) while the car is being driven. Also features remote control and connections for MP3 players, games consoles and headphones (also wireless).

Standard / Optional equipment.



□ **Comfort Access** allows keyless access to the vehicle via the driver's door, front passenger door and the tailgate. Also includes courtesy lighting of the front and rear exterior door handles as well as contactless opening of the tailgate which involves a small movement of the foot beneath the rear bumper.



■ **Two-section tailgate.** Smaller items can be quickly and easily stowed in the vehicle, and without allowing in draughts, via a separate section below the rear window. Standard automatic tailgate operation can also be used.



□ **BMW Individual sun-protection glazing** helps to control interior heat levels while allowing desired temperatures to be reached more quickly.



□ **Sunblinds for the rear side windows** can be electrically raised and lowered. They protect against intense sunlight while also providing effective privacy.



□ **Auxiliary heating,** including timer, for individual temperature control of the cabin in cold temperatures without having to start the engine. This avoids the need to deal with frozen-up windows and fogging. In warmer temperatures, the integrated auxiliary ventilation provides a pleasantly cool interior.



□ **BMW Welt.** Vehicle collection at the BMW Welt is one of the most special moments for any driver. Turn that moment into an unforgettable day with a programme that perfectly matches your requirements. To find out more, please go to www.bmw-welt.com



□ **BMW Service Inclusive.** When it comes to service, your BMW partner is also ready with an intelligent solution. With BMW Service Inclusive, there are no additional costs for regular maintenance work within an agreed term or mileage limit. For more information, please go to www.bmw.com/ServiceInclusive

Original BMW Accessories*.



21" light alloy wheels V-spoke 463 Ferric Grey; bicycle/e-bike holder for the trailer tow hitch.



Travel & Comfort System folding table, offers rear passengers a practical surface and is adjustable for both height and incline.



Ski and snowboard bag Luxury, for clean transport of up to four pairs of skis or three snowboards. Attaches securely to the lashing eyes in the boot.



Sun blinds



Snap-in media adapter for using the telephone or listening to music.



Wing mirror caps, chrome. Perfectly round off the individual appearance of the BMW 5 Series Gran Turismo.



BMW holder for Apple iPad with base support that attaches to the front seat headrest bars.

Driving a BMW is always a special experience, but it can be made even more so with Original BMW Accessories thanks to their combination of unique ideas, supreme functionality and clever design. Discover a wide range of innovative features for the exterior and interior as well as for communication and information. There are also many solutions for transportation and the luggage compartment. Your BMW Service partner will be pleased to advise you on the complete range of Original BMW Accessories and will have a special catalogue waiting for you. For more information please visit www.bmw.com/accessories

* May not be available in all countries. Please consult your BMW partner.

		535i 535i xDrive	550i 550i xDrive	520d	530d 530d xDrive	535d 535d xDrive
--	--	---------------------	---------------------	------	---------------------	---------------------

Weight						
Unladen, EU ¹	kg	2015	2145	1990	2015	2045
Unladen EU ¹ (xDrive)	kg	2070	2215	–	2120	2145
Max. permissible weight	kg	2570	2670	2545	2570	2600
Max. permissible weight (xDrive)	kg	2625	2730	–	2665	2670
Permitted load	kg	630	600	630	630	630
Permitted load (xDrive)	kg	630	590	–	620	600
Permitted trailer load, unbraked ²	kg	750	750	750	750	750
Permitted trailer load, unbraked (xDrive) ²	kg	750	750	–	750	750
Permitted trailer load, braked, max. 12% gradient/max. 8% gradient ²	kg	2100/2100	2100/2100	2100/2100	2100/2100	2100/2100
Permitted trailer load, braked, max. 12% gradient/max. 8% gradient (xDrive) ²	kg	2100/2100	2100/2100	–	2100/2100	2100/2100

Engine ^{3,4}						
Cylinders/valves		6/4	8/4	4/4	6/4	6/4
Capacity	cc	2979	4395	1995	2993	2993
Max. output/engine speed	kW (hp)/rpm	225 (306)/5800	330 (450)/5500	135 (184)/4000	190 (258)/4000	230 (313)/4400
Max. torque/engine speed	Nm/rpm	400/1200 – 5000	650/2000 – 4500	380/1750 – 2750	560/1500 – 3000	630/1500 – 2500

Power transmission						
Drive configuration		Rear-wheel/all-wheel	Rear-wheel/all-wheel	Rear-wheel	Rear-wheel/all-wheel	Rear-wheel/all-wheel
Standard transmission		Eight-speed Steptronic	Eight-speed Steptronic	Eight-speed Steptronic	Eight-speed Steptronic	Eight-speed Steptronic
Standard transmission (xDrive)		Eight-speed Steptronic	Eight-speed Steptronic	–	Eight-speed Steptronic	Eight-speed Steptronic

Performance						
Top speed	km/h	250 ⁵	250 ⁵	215	246	250 ⁵
Top speed (xDrive)	km/h	250 ⁵	250 ⁵	–	243	250 ⁵
Acceleration 0 – 100km/h	s	6.1	5.0	8.9	6.2	5.7
Acceleration 0 – 100km/h (xDrive)	s	6.1	4.8	–	6.2	5.6

Fuel consumption ^{3,4}						
Urban	l/100km	11.2 – 11.6	12.4 – 12.7	6.2 – 6.4	6.8 – 7.0	6.8 – 7.1
Urban (xDrive)	l/100km	11.5 – 11.7	13.0 – 13.3	–	7.2 – 7.5	7.6 – 7.9
Extra-urban	l/100km	6.5 – 6.7	7.3 – 7.5	5.0 – 5.2	5.2 – 5.5	5.3 – 5.5
Extra urban (xDrive)	l/100km	6.7 – 6.9	7.7 – 7.9	–	5.6 – 5.8	5.7 – 5.9
Combined	l/100km	8.2 – 8.5	9.2 – 9.4	5.5 – 5.7	5.8 – 6.0	5.9 – 6.1
Combined (xDrive)	l/100km	8.5 – 8.6	9.6 – 9.9	–	6.2 – 6.4	6.4 – 6.6
Combined CO ₂ emissions	g/km	192 – 198	214 – 220	144 – 149	153 – 159	154 – 159
Combined CO ₂ emissions (xDrive)	g/km	203 – 205	224 – 230	–	163 – 169	168 – 174
Tank capacity, approx.	l	70	70	70	70	70

Wheels/tyres						
Tyre dimensions, front/rear		245/50 R 18 Y	245/45 R 19 Y/ 275/40 R 19 Y	245/50 R 18 Y	245/50 R 18 Y	245/50 R 18 Y
Wheel dimensions, front/rear		8 J x 18	8.5J9.5 J x 19	8 J x 18	8 J x 18	8 J x 18
Material		light alloy	light alloy	light alloy	light alloy	light alloy

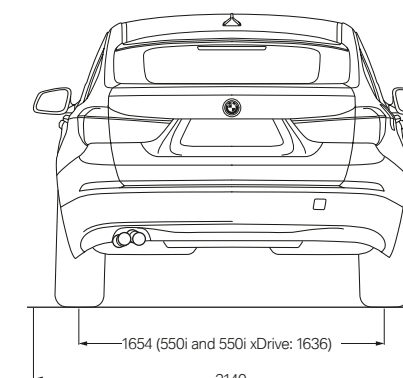
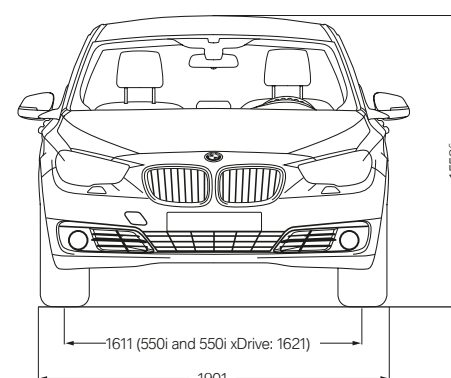
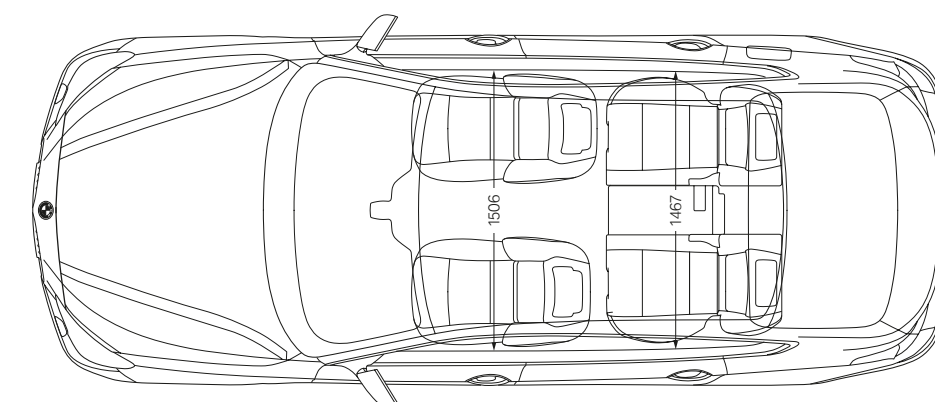
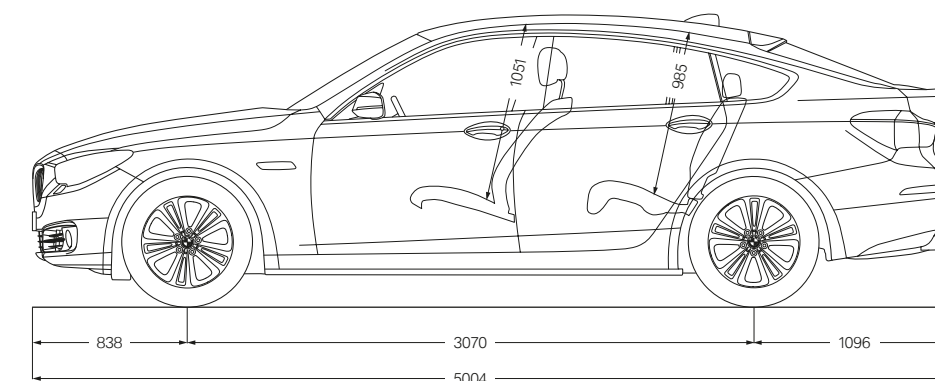

All dimensions in the technical drawings are given in millimetres.

Luggage compartment volumes:

Rear seats all the way back/separating panel locked 500 litres, rear seats all the way forward/separating panel vertical 610 litres, rear seats and separating panel folded down 1,700 litres.

¹ Figures are based on a 90% tank filling, driver's weight of 68kg and 7kg of luggage. Unladen weight applies to vehicles with standard equipment. Optional extras may increase these figures.

² The overall weight of the trailer may not exceed the maximum permissible trailer load, taking into account the maximum permissible towbar download.

³ BMW recommends the use of RON 95 super unleaded petrol. Unleaded RON 91 and higher with a maximum ethanol content of 10% (E10) may also be used. Output and fuel consumption figures apply to RON 98 fuel.

⁴ All engines conform to the EU6 emissions standard. Fuel consumption is determined according to the ECE combined cycle in which approx. one-third of the distance covered is in urban traffic and two-thirds is extra-urban. CO₂ emissions are measured in addition to fuel consumption. Optional equipment can increase these figures. For more information on fuel consumption and CO₂ emissions, please consult your BMW partner.

⁵ Electronically limited.

⁶ With roof antenna 1,564mm.

WELL TAKEN CARE OF WITH BMW SERVICES:

When you buy a BMW, you can look forward to superb service and comprehensive customer care. For example, the **Condition Based Service** independently tracks both service fluid levels and the condition of parts subject to wear and then notifies you in the display when the vehicle requires servicing. So you only need to go to your BMW service partner when it's really necessary. When you do go, our

qualified BMW service specialists take care of your vehicle using the newest workshop technology and only **original BMW parts**. This service is available worldwide in more than 3,300 BMW service partner establishments in over 150 countries, to provide you with limitless driving pleasure.

BMW SERVICE.



BMW Service Packages*: Individual and stress-free, just for you. Individual, well-thought-out servicing solutions carefully tailored to you and your vehicle. With one-off, predictable costs, BMW Service Packages give you complete peace of mind, so you can enjoy owning a BMW to the very fullest. Whether it's fresh from the showroom or already well-travelled – there's a BMW Service Package for every phase of your vehicle's life. All bringing you maximum quality, expertise and value retention, always at reasonable, transparent rates. And always carefully tailored to you and your BMW. Find out just how stress-free truly individual service can be!

www.bmw.com/serviceinclusive



BMW Mobile Service*: This service is there for you day and night. As soon as you call, we spring into action, and take care of everything that may need doing after an accident or breakdown, with specially trained technicians working – on site or via telephone – to get your car back on the road. We offer comprehensive, country-specific mobility packages for breakdowns, and insurance that covers you in the event of an accident or theft. So if anything untoward does happen, simply call up the BMW accident hotline and we'll go to work. We'll take care of calling the emergency services, a tow truck, a replacement car, notifying your insurance company and much more. For further information please visit www.bmw.com



BMW TeleServices*: With Condition Based Service, you'll be automatically reminded of your next necessary service appointment on the vehicle screen. Provided you've consented, key vehicle data will be relayed to BMW automatically for analysis. Your assigned BMW service partner will access the information and contact you free of charge to make a service appointment as and when necessary. To access BMW Teleservices, the vehicle must be equipped with the optional Intelligent Emergency Call or ConnectedDrive Services. The service can be deactivated at any time you so desire, and you can change your service partner in the iDrive menu or ConnectedDrive portal. Find out more at www.bmw.com/teleservices

BMW FINANCIAL SERVICE.



BMW Financial Services*: Mobility solutions to meet your needs. BMW Financial Services provides you with attractive leasing, finance and insurance options. To find out more, see the price list or go to www.bmwfs.com. Your BMW partner will also be glad to draw up an individual offer for you in person.

THE BMW EXPERIENCE.



BMW TV*: www.bmw.tv enables you to experience the BMW brand in all its diversity. Features, portraits and background reports provide you with information on automobiles, innovations, sports and lifestyle topics.



BMW Driving Experience: The better you control your BMW, the more enjoyment you will derive from driving it. Use our training courses to learn for yourself what it means to reach a car's physical limits on various types of surfaces, and what you have to do to control your vehicle even in extreme situations. For further information please visit www.bmwdrivingexperience.com



BMW Welt: Picking up a car at BMW Welt has always ranked among the best moments for any driver. Turn this moment into one whole unforgettable day: experience the handover of your new BMW as just one part of a programme of activities perfectly tailored to your interests. At BMW Welt, you are surrounded by the BMW Museum, the main BMW factory, and the BMW Group headquarters, representing an exciting history, a breathtaking present – and spectacular visions for the future. Find out more at www.bmw-welt.com/en



BMW Magazine: In BMW Magazine, experience the newest BMW models in front of stunning backdrops. Discover new design trends, travel destinations and the richness of modern life. Encounter people with visionary ideas who are changing the world. Find out more at www.bmw.com/magazine

* May not be available in all countries. Please consult your BMW partner.

SHAPING THE FUTURE – RESPONSIBLY.

In 2015, the BMW Group was once more listed in the World and European Dow Jones Sustainability Index as one of the most sustainable automotive companies worldwide. The development of efficient vehicle concepts and environmentally friendly production processes, including recycling, is an integral part of our philosophy. BMW EfficientDynamics and electric vehicles have enabled us to cut the CO₂ emissions from our European new-vehicle fleet by more than 35% since 1995. We have also reduced the amount of resources used in production, such as water and energy, by 34% between 2006 and 2014, with a reduction to 45% of previous levels aimed at for 2020. In terms of other resources (such as volatile organic compounds, process wastewater and waste) our 45% target was met in 2014, and we will continue to work on further improvement. Production at our engine plant in Steyr has been waste-water free since 2007. And of course, at the end of its service life, every one of our vehicles can be easily and economically recycled. To return your end-of-life vehicle, please contact your BMW partner. For more information on this issue please visit our website.

www.bmw.com/EfficientDynamics
www.bmwgroup.com/responsibility
www.bmw.com/recycling

More about BMW



Sheer
Driving Pleasure

www.bmw.com

The models illustrated in this brochure show the specifications of vehicles produced by BMW AG for the German market. In part, they include optional equipment and accessories not fitted as standard. According to the specific requirements of other markets, alterations in models, standard and optional equipment, as described in this brochure, may occur. For more precise information about country-specific vehicle versions, please contact your local BMW partner. Subject to change in design and equipment.

© BMW AG, Munich/Germany. Not to be reproduced wholly or in part without written permission of BMW AG, Munich.

4 11 005 060 201 2016 BB. Printed in Germany 2016.

