

BMW 2 Series  
Gran Tourer  
Active Tourer



Sheer  
Driving Pleasure

[www.bmw.com](http://www.bmw.com)

# THE BMW 2 SERIES GRAN TOURER AND ACTIVE TOURER.

**BMW EFFICIENT DYNAMICS.**  
LESS EMISSIONS. MORE DRIVING PLEASURE.

THE NEXT  
100 YEARS





In 2016 the BMW brand will be celebrating its 100th anniversary. Find out more at [www.next100.bmw](http://www.next100.bmw)

## WANT TO DISCOVER MORE?



Discover the BMW 2 Series Active Tourer and BMW 2 Series Gran Tourer in digital, with videos and image galleries. Simply download the interactive BMW brochure app for your device and select the model of your choice.

Depending on the terms of your mobile phone plan you might incur additional costs for accessing the internet.

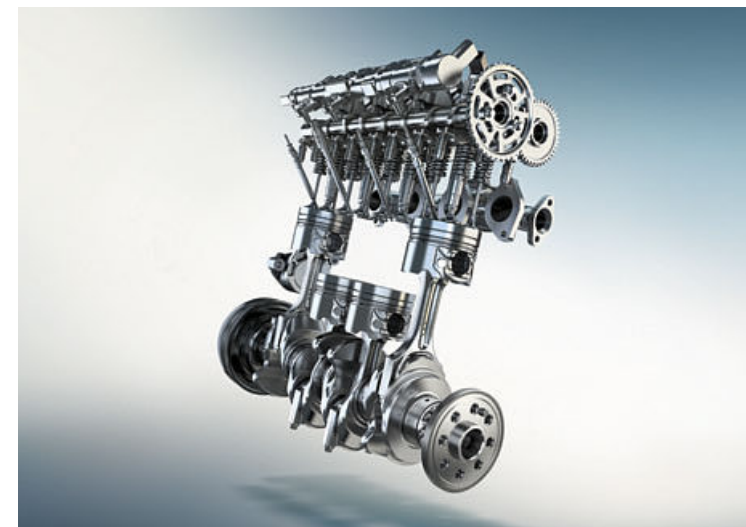

## THE BMW 2 SERIES GRAN TOURER AND ACTIVE TOURER.

### THE MODELS SHOWN.

#### 04 BMW 2 SERIES GRAN TOURER 220d xDRIVE WITH SPORT LINE:

BMW TwinPower Turbo 4-cylinder diesel engine, 140 kW (190 hp), 18" light alloy wheels Y-spoke style 484, exterior paint finish in Flamenco Red brilliant effect metallic, seats in leather 'Dakota' Black with perforations and contrast stitching in Red, interior trim finisher Aluminium, finely brushed lengthwise and highlight trim finisher Pearl Chrome.

#### BMW 2 SERIES ACTIVE TOURER 225i WITH LUXURY LINE:

BMW TwinPower Turbo 4-cylinder petrol engine, 170 kW (231 hp), 18" light alloy wheels V-spoke style 485, Platinum Silver metallic paint finish, seats in Leather 'Dakota' Canberra Beige with perforations, interior trim finisher in fine-wood trim Finition Shore with inlays and accent trim finisher Pearl-Gloss Chrome.

#### BMW 2 SERIES ACTIVE TOURER 225xe iPERFORMANCE WITH LUXURY LINE:

BMW TwinPower Turbo 3-cylinder petrol engine and electric motor with a system output of 165 kW (224 hp), 18" light alloy wheels V-spoke style 485, Glacier Silver metallic paint finish, seats in leather 'Dakota' Canberra Beige with perforations, Finition Shore fine-wood interior trim with inlay and Pearl-Gloss Chrome accent line.

### INNOVATION AND TECHNOLOGY.

#### 24 BMW TWIN POWER TURBO ENGINES:

At the heart of BMW EfficientDynamics.

#### 26 BMW EFFICIENT DYNAMICS:

Maximum driving pleasure, minimum fuel consumption.

#### 28 BMW CONNECTED DRIVE:

Services & Apps and driver assistance systems.

#### 30 CHASSIS:

Innovative systems for more driving pleasure.

#### 31 SAFETY:

State-of-the-art technology.

### INDIVIDUALITY AND CHOICE.

**34 EQUIPMENT:** BMW models, BMW Active Tourer with eDrive, equipment highlights, wheels and tyres and Original BMW Accessories.

**50 COLOURS:** Exterior and interior colours.

**54 TECHNICAL DATA:** Vehicle weight, engine, transmission, driving performance, fuel consumption, wheels and technical drawings.

**58 BMW SERVICES:** BMW Service, BMW Financial Services and BMW Experience.

Further information on fuel consumption and CO<sub>2</sub> emissions can be found on pages 54 | 55 and 56 | 57 or consult your BMW partner.

# ROCK 'N' ROLL.

**Newcomer of the year.** The BMW 2 Series Gran Tourer combines functionality and spaciousness with the classic BMW characteristics: driving pleasure and dynamics. In every moment and from every perspective, it makes a great impression, offering plenty of space and the greatest possible flexibility. Whether you're enjoying its athleticism or ferrying the band to the concert, with the BMW 2 Series Gran Tourer, going on tour always makes a hit.



# BECAUSE FATHERS ARE MEN TOO.

**Versatility shows its athletic side.** With the BMW 2 Series Gran Tourer, BMW has proven just how good a spacious vehicle can look. The wedge-shaped body charges forward driven by the newest generation of BMW TwinPower Turbo engines. It is the first vehicle in its class to be equipped with the intelligent xDrive all-wheel drive, providing even more driving pleasure and improving safety. So it raises your pulse – when you want it to.





## GROUP DYNAMICS.

**In the BMW 2 Series Gran Tourer, there's no need for "either/or", but plenty of room for "as well".** There's room for up to seven people in the light and airy interior under the optional Panorama glass roof. In the front row, the driver-oriented cockpit is wholly focussed on the driver's requirements. The second row of seats has room for up to three child seats, and the optionally available third row of seating has two fully equipped, comfortable seats. There's also maximum flexibility with large doors for comfortable entry, a rear seat that can be shifted laterally, and electrically collapsible rear seat backrests. Once you're behind the wheel, you'll see what you get out of this arrangement: the best of everything.



# THE PERFECT COMPANION.

**Beautifully compact on the outside, beautifully flexible on the inside.** The BMW 2 Series Active Tourer shows how much fun functionality can be. Its powerful contours and dynamic lines combine everyday practicality with driving pleasure in a truly harmonious union. What's more, it combines intelligent flexibility with comfort and dynamics. And no matter what you get up to, it's incredibly fun to drive. Not only does it look like a BMW, it also drives like one.





## LOOKS RIGHT, DRIVES RIGHT.

**The BMW 2 Series Active Tourer has everything you expect of a BMW.** The low-set tailgate with the classic BMW L-shaped lights gives the vehicle's impulsion an athletically dynamic touch. The luxurious interior combines ergonomic comfort with a certain lightness that can be experienced by every occupant, every time.





# ROOM FOR EVERYTHING. EXCEPT BOREDOM.

**Enjoy its size.** The elevated seating position makes getting in and out of the BMW 2 Series Active Tourer much more comfortable for passengers. The rear seat backrest and the front passenger backrest<sup>1</sup> can be folded down flat to create more space for bulky luggage. The capacious tailgate aperture and low loading sill help make loading up the boot easier than ever – the BMW 2 Series Active Tourer crams practicality into every detail.

<sup>1</sup> Optional folding front passenger backrest not available with sport seats and/or electrical seat adjustment.



# WELCOME TO THE FAMILY.

**Functional, flexible and fit.** The BMW 2 Series Gran Tourer and BMW 2 Series Active Tourer, also available as a plug-in-hybrid, make the everyday exceptional. All models offer plenty of space while remaining fun to drive – whatever type of engine you opt for. Relish the sportiness typical of BMW, making every trip an adventure.





## EXCELS, EVEN WHEN POWERED ELECTRICALLY.

**Intelligent flexibility:** The BMW 2 Series Active Tourer 225xe iPerformance for the first time combines BMW eDrive technology with a transverse front-mounted 3-cylinder petrol engine and front-wheel drive. The electric motor on the rear axle allows for electric all-wheel drive unique in this segment, and thus for optimum traction. The perfect synergy of the high-voltage lithium-ion battery and the intelligent energy management gives you up to 41 km on electrical drive alone, so you can enjoy short urban journeys, for example, without creating emissions. And with intelligent BMW 360° ELECTRIC charging solutions for the home you're ever-ready for your next adventure. Experience lasting excitement in the BMW 2 Series Active Tourer 225xe iPerformance.



## INNOVATION AND TECHNOLOGY.

**BMW TWIN POWER TURBO ENGINES:** At the heart of BMW EfficientDynamics.

**BMW EFFICIENT DYNAMICS:** Maximum driving pleasure, minimum fuel consumption.

**BMW CONNECTED DRIVE:** Services & Apps and driver assistance systems.

**CHASSIS:** Innovative systems for more driving pleasure.

**SAFETY:** State-of-the-art technology.

## BMW TwinPower Turbo engines. At the heart of BMW EfficientDynamics.

Thanks to BMW TwinPower Turbo technology, the innovative new generation of BMW petrol and diesel engines from the BMW EfficientDynamics engine range can deliver an agile performance and excellent responsiveness even at low engine speeds, all while being exceptionally fuel efficient and low in emissions. Increased efficiency and optimal dynamics guarantee noticeably more intense driving pleasure.

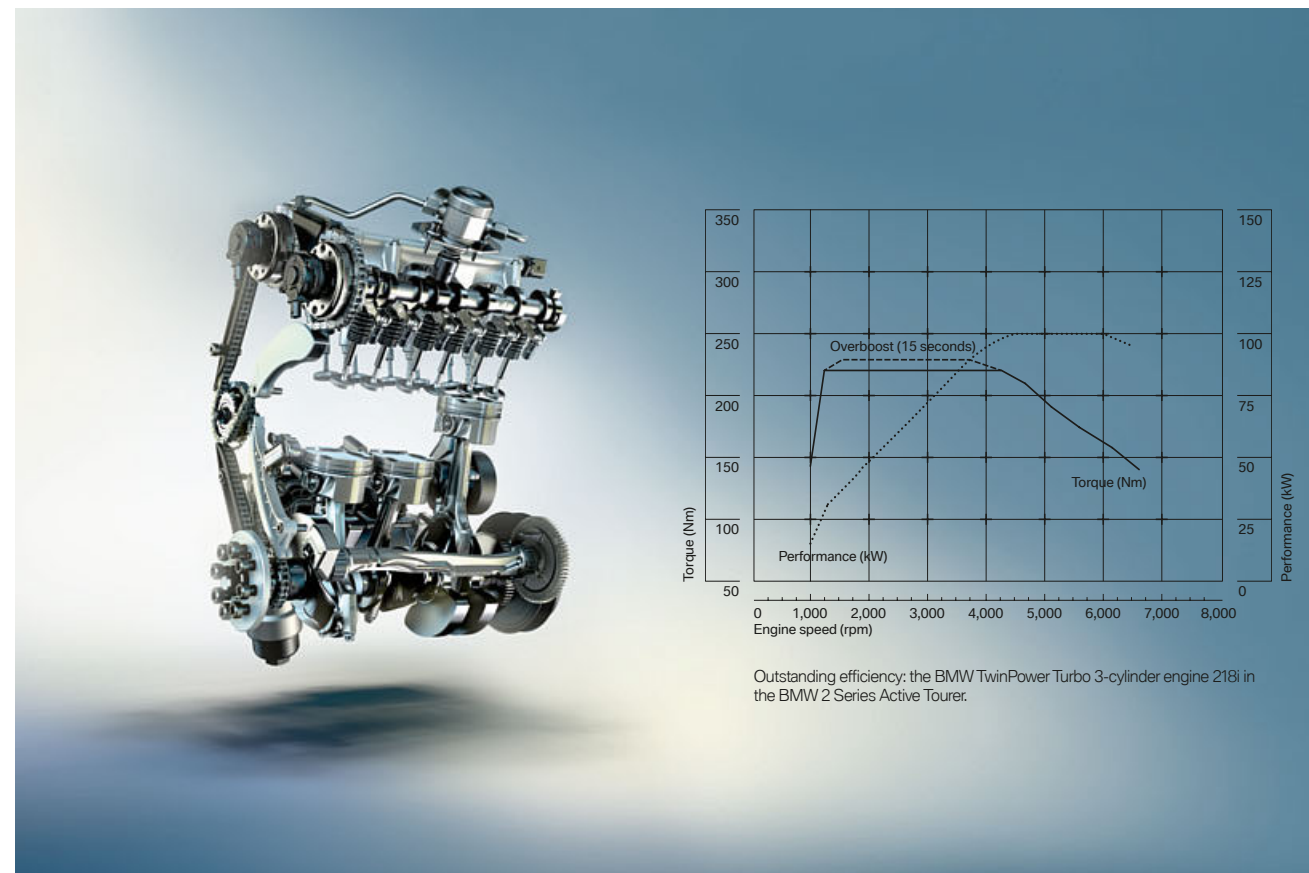

### BMW TWIN POWER TURBO 3-CYLINDER PETROL ENGINE 218i.

The agile 3-cylinder engine powers this BMW 218i Active Tourer in 9.3 s from 0 to 100 km/h, peaking out at a top speed of 205 km/h. Even with such a remarkable performance, this very low-friction, highly efficient 3-cylinder engine is impressively frugal.

### BMW 225i/225i xDrive Active Tourer.

- BMW TwinPower Turbo 4-cylinder petrol engine with 170 kW (231 hp) and 350 Nm torque
- Acceleration 0–100 km/h: 6.6 s (xDrive: 6.3 s); top speed: 238 km/h (xDrive: 235 km/h)
- Combined fuel consumption: 5.8–6.0 l/100 km (xDrive 6.4–6.5 l/100 km)
- CO<sub>2</sub> emissions combined: 135–139 g/km (xDrive 148–152 g/km)

### BMW 220i Active Tourer / Gran Tourer.

- BMW TwinPower Turbo 4-cylinder petrol engine with 141 kW (192 hp) and 280 Nm torque
- Acceleration 0–100 km/h: 7.5 s / 7.7 s; top speed: 230 km/h / 223 km/h
- Combined fuel consumption: 5.9–6.1 l/100 km / 6.2–6.4 l/100 km
- CO<sub>2</sub> emissions combined: 137–142 g/km / 144–149 g/km

### BMW 218i Active Tourer / Gran Tourer.

- BMW TwinPower Turbo 3-cylinder petrol engine with 100 kW (136 hp) and 220 Nm torque
- Acceleration 0–100 km/h: 9.3 s / 9.5 s; top speed: 205 km/h / 205 km/h
- Fuel consumption combined: 5.1–5.3 l/100 km / 5.1–5.4 l/100 km
- CO<sub>2</sub> emissions combined: 119–124 g/km / 119–125 g/km

### BMW 216i Active Tourer / Gran Tourer.

- BMW TwinPower Turbo 3-cylinder petrol engine with 75 kW (102 hp) and 180 Nm torque
- Acceleration 0–100 km/h: 11.4 s / 11.9 s; top speed: 188 km/h / 185 km/h
- Combined fuel consumption: 5.4–5.6 l/100 km / 5.3–5.6 l/100 km
- CO<sub>2</sub> emissions combined: 123–128 g/km / 124–129 g/km

### BMW 220d/220d xDrive Active Tourer / Gran Tourer.

- BMW TwinPower Turbo 4-cylinder diesel engine with 140 kW (190 hp) and 400 Nm torque
- Acceleration 0–100 km/h: 7.6 s (xDrive: 7.3 s) / 7.9 s (xDrive: 7.6 s); top speed: 227 km/h (xDrive: 222 km/h) / 222 km/h (xDrive: 218 km/h)
- Combined fuel consumption: 4.4–4.5 l/100km (xDrive: 4.7–4.9 l/100km) / 4.5–4.7 l/100 km (220d xDrive: 4.9–5.1 l/100 km)
- CO<sub>2</sub> emissions combined: 115–119 g/km (xDrive: 124–129 g/km) / 119–124 g/km (xDrive: 128–133 g/km)

### BMW 218d/218d xDrive Active Tourer / Gran Tourer.

- BMW TwinPower Turbo 4-cylinder diesel engine with 110 kW (150 hp) and 330 Nm torque
- Acceleration 0–100 km/h: 8.9 s (xDrive: 8.6 s) / 9.3 s (xDrive: 8.9 s); top speed: 208 km/h (xDrive: 208 km/h) / 205 km/h (xDrive: 205 km/h)
- Combined fuel consumption: 4.1–4.3 l/100 km (xDrive: 4.7–4.9 l/100 km) / 4.3–4.5 l/100 km (xDrive: 4.9–5.1 l/100 km)
- CO<sub>2</sub> emissions combined: 109–114 g/km (xDrive: 124–129 g/km) / 114–119 g/km (xDrive: 128–133 g/km)

### BMW 216d Active Tourer / Gran Tourer.

- BMW TwinPower Turbo 3-cylinder diesel engine with 85 kW (116 hp) and 270 Nm torque
- Acceleration 0–100 km/h: 10.6 s / 11.1 s; top speed: 195 km/h / 192 km/h
- Combined fuel consumption: 3.8–3.9 l/100 km / 3.9–4.1 l/100 km
- CO<sub>2</sub> emissions combined: 99–104 g/km / 104–109 g/km

### BMW 225xe iPerformance.

- BMW TwinPower Turbo 3-cylinder petrol engine and electric motor with system output system of 165 kW (224 hp) and 385 Nm system torque
- Acceleration 0–100 km/h: 6.7 s; top speed 202 km/h; electr. top speed: 125 km/h
- Combined fuel consumption: 2.0–2.1 l/100 km
- CO<sub>2</sub> emissions combined: 46–49 g/km

**BMW EFFICIENT DYNAMICS.**  
LESS EMISSIONS. MORE DRIVING PLEASURE.

Fuel consumption and CO<sub>2</sub> emissions are affected by the selected tyre sizes (respective higher figures refer to models with optional equipment tyres.) Further information on fuel consumption and CO<sub>2</sub> emissions can be found on pages 54–57.

The quoted performance, fuel consumption and CO<sub>2</sub> emissions figures are for vehicles with standard transmissions.

## BMW EfficientDynamics

### Less emissions. More driving pleasure.

Whether its maximum performance or minimum consumption – with BMW, everything revolves around the renowned BMW sheer driving pleasure. BMW EfficientDynamics is the BMW strategy for minimising fuel consumption and CO<sub>2</sub> emissions while at the same time maximising dynamism and driving pleasure. It is a package of measures that cover the drive, the energy management system, and the vehicle design – as standard, in every BMW.

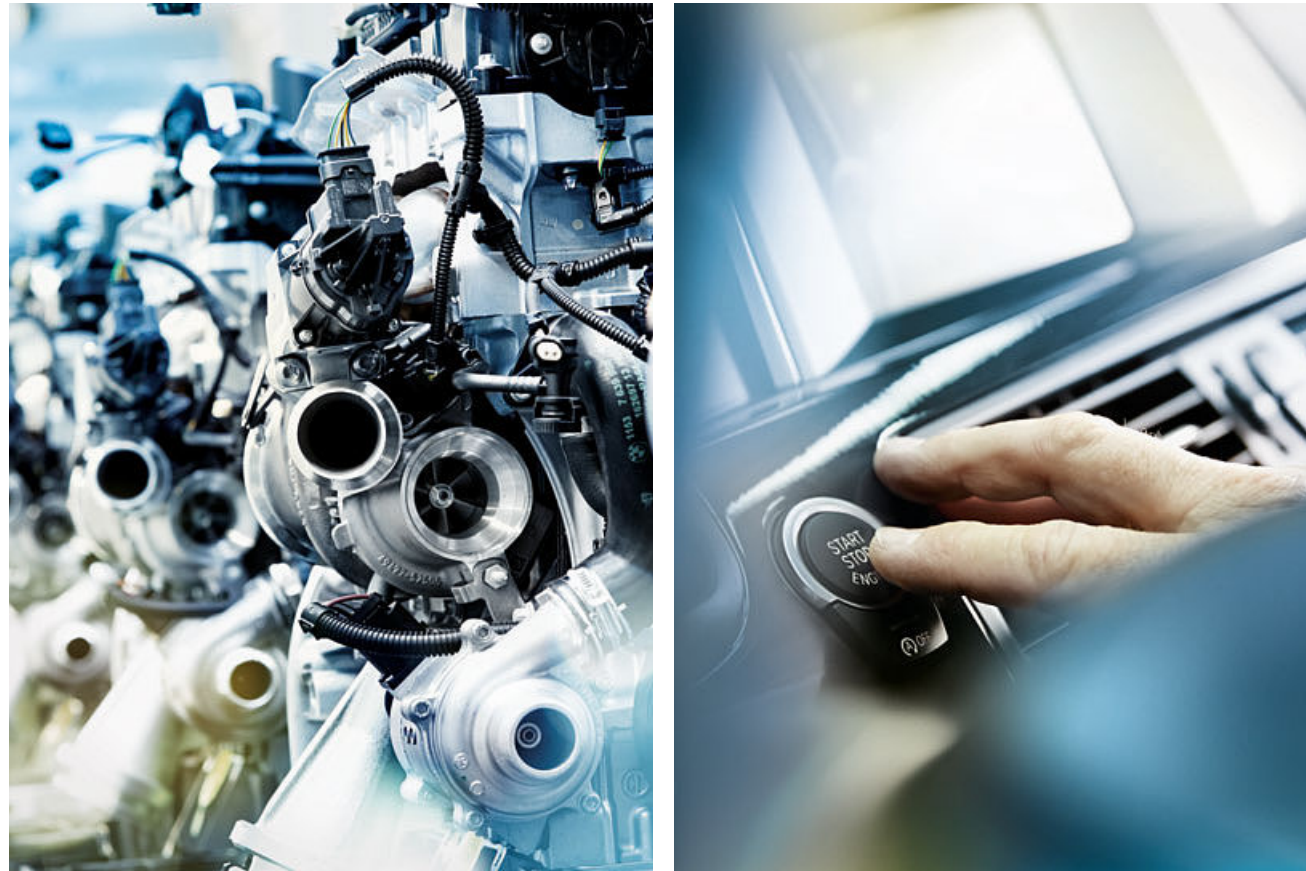

#### EXCEPTIONAL: THE ECO PRO MODE.

The ECO PRO Mode helps drivers reduce their fuel consumption by up to 20 percent, depending on their driving style – according to an internal BMW fuel consumption study. The coasting function (only available with Steptronic transmission) and ECO PRO Route (only available with Navigation System) further help to conserve fuel.



#### ENGINE.

The BMW TwinPower Turbo technology concept is used in all BMW **petrol engines**. Innovative turbocharger technology combined with High Precision Injection and the fully variable Valvetronic valve control system, including Double-VANOS, all serve to improve performance, provide exceptional responsiveness even at low engine speeds and reduce fuel consumption.

The BMW TwinPower Turbo technology in the **diesel engines** combines the latest fuel injection technologies and fully variable turbine geometry with innovative turbocharger technology for enhanced efficiency and a more dynamic performance. All available engines feature a lightweight aluminium design and come with a maintenance-free particle filter.

#### OVERALL CONCEPT.

Intelligent lightweight construction at BMW means using the right material at the right place in the vehicle. The most suitable material is selected for each individual component. This approach, also referred to as **BMW EfficientLightweight**, is currently an integral component of BMW EfficientDynamics and used in every BMW.

#### ENERGY MANAGEMENT.

The **Automatic Start/Stop function** switches off the engine when the vehicle comes to a temporary standstill (e.g. at traffic lights or in a traffic jam) to further reduce overall fuel consumption. When the driver presses down on the clutch (manual transmission) or takes their foot off the brake (Steptronic transmission), the engine automatically starts up again in a fraction of a second.

**Optimum Shift Indicator.** Optimal, perfectly-timed gear changes can help save fuel, particularly in urban traffic and over long distances. Optimal gear changes, less fuel consumption – the engine's electronics system identifies the most efficient gear based on the driving situation and engine speed. An arrow lights up in the Info Display to show when it would be more efficient to shift into a higher or lower gear. The system also recognises when the vehicle is accelerating fast, and will delay its recommendation accordingly until the engine speed is back up. Vehicles with Steptronic transmissions also feature gear change recommendations when in manual mode. Internal BMW comparative tests have shown that vehicles with the Optimum Shift Indicator achieve fuel savings of around four percent.

Every time you brake, kinetic energy is generated, and until recently this energy has gone unused. **Brake Energy Regeneration** takes advantage of this long-overlooked potential. It harnesses the coasting energy that is generated whenever the driver brakes or takes their foot off the accelerator and turns it into electricity. This electricity is then used to charge the car battery. The intelligent energy management system means that the alternator no longer needs to run constantly, which reduces the strain on the generator. The result: reduced fuel consumption and increased performance – classic BMW EfficientDynamics.

# BMW ConnectedDrive

## So connected, you're free.

Our world is becoming more closely connected every day. And for BMW drivers it goes without saying that they can request information, communicate via telephone or email and always be up to date – all while they're on the go. The BMW ConnectedDrive<sup>1</sup> concept encompasses all the services and innovative technologies that link BMW vehicles and their passengers to the outside world and surrounding traffic.



The equipment option **ConnectedDrive Services\*** forms the basis for BMW ConnectedDrive functions, which provide the driver with a wide range of information, entertainment and service features while on the road.

The offer includes access to current location-based information such as weather and news, as well as an online search powered by Google™ and practical office functions. Services and features such as parking information, as well as travel and hotel guides can be accessed directly in the car without a smartphone via the ConnectedDrive menu.

Convenient, secure and unlimited access to selected smartphone apps is also integrated. ConnectedDrive Services also provides access to the **BMW ConnectedDrive Store**, in which services and apps can be ordered and extended anytime and anywhere to suit the user's individual requirements. The equipment option ConnectedDrive Services offers all this and more, making every trip in a BMW a real experience.

BMW ConnectedDrive encompasses a wide range of intelligent services and assistance systems, allowing anybody to choose just what they need. The **BMW ConnectedDrive Services & Apps** provide greater flexibility by networking the driver, car and the outside world. The **BMW ConnectedDrive driver assistance systems** make every drive in a BMW both safer and more convenient. Intelligent systems make the driver's job easier and minimise the risk of accidents.



**Everything you need to see.** The optional full-colour BMW Head-Up Display<sup>2</sup> projects all relevant information onto a screen positioned comfortably within the driver's field of view, so that you stay informed while keeping your eyes on the road. The display includes information such as the current speed, navigation directions, Speed Limit Info incl. no-overtaking indicator, along with telephone and entertainment lists.



**Music to go.** To ensure that every trip in your BMW becomes an unforgettable experience, the vehicle comes with music apps that play the right song for every occasion. Whether commuting to work, going shopping or heading off on holiday, you can compile your own radio station, choose between a huge array of audio books or stream your own music – all from the comfort of your BMW with the BMW ConnectedDrive Services optional equipment.

**Simply feels good.** The Driving Assistant combines the Lane Departure Warning and Approach Warning systems. The Approach and Pedestrian Warning with City Brake Activation issues a warning if there is a risk of collision with vehicles or pedestrians and brakes the vehicle in the event of an emergency. From a speed of approx. 70 km/h, the Lane Departure Warning draws the driver's attention to an unintentional lane change by means of slight vibrations in the steering wheel.

\* May not be available in all countries. Please consult your BMW partner.

<sup>1</sup> For further information on BMW ConnectedDrive, please visit [www.bmw.com/ConnectedDrive](http://www.bmw.com/ConnectedDrive)

<sup>2</sup> Only available in conjunction with the optional equipment Navigation Plus. The information displayed is not fully visible when wearing polarised sunglasses. The exact content shown on the BMW Head-Up Display will depend on the equipment options chosen. Further optional equipment is required for the display.

## Chassis.

A solid foundation for superior driving dynamics.



The **intelligent xDrive all-wheel drive system** adapts almost perfectly to even the most challenging road surface conditions, while providing outstanding traction at all times. xDrive and Dynamic Stability Control (DSC) provide excellent directional stability. xDrive distributes drive power – directed via DSC sensors – between the axles, intervening early in order to prevent oversteer or understeer from even developing, thereby ensuring outstanding directional stability. DSC thus has to intervene less in difficult road conditions. BMW xDrive effectively combines the advantages of a four-wheel drive – traction, directional stability and safety – with characteristic BMW agility for maximum of driving pleasure.

**BMW Performance Control**, a standard feature, distributes engine and braking power to the individual wheels so as to better manage curves. As the outer wheels have to move a longer distance than the inner wheels when turning, the BMW Performance Control intervenes by means of engine output and controlled braking: the outer wheels get more power while the inner wheels get less, maximising traction on each of the wheels. The vehicle practically leads itself through the bend, increasing driving dynamics and safety.

The optional **variable sport steering**<sup>1</sup> with Servotronic enables a direct and agile driving style with less physical effort when steering. It deploys different steering ratios depending on the steering wheel angle, regardless of the speed. This reduces the steering movement required when steering at particularly large angles, which in turn noticeably increases agility and improves handling when driving through sharp bends, tight curves and sudden swerves or when using an especially dynamic driving style. At the same time, it increases comfort when parking, turning and manoeuvring. For small steering angles, the system provides excellent directional stability and a very high degree of steering precision.

The optional **Dynamic Damper Control**<sup>1</sup> makes it possible to constantly adjust the damper characteristics to suit any given driving situation, increasing the vehicle's comfort or heightening its driving dynamics. In addition to the standard COMFORT setting which assures a smooth and comfortable ride, there is also a SPORT mode. This setting stiffens the damper for a more direct, athletic driving performance. Each mode is activated with the Driving Experience Control switch in the centre console.

The **Driving Experience Control** lets the driver choose between the standard COMFORT mode, the ECO PRO mode, geared towards efficiency, and the SPORT mode, for an even more dynamic drive. The ECO PRO Mode adjusts the characteristics of the Steptronic transmission, if selected, as well as the heating/air conditioning settings to make your driving as fuel-efficient as possible.

A world first: The modern **front wheel drive concept** by BMW, which consolidates active driving expectations and steering convenience. The powered front axle has been engineered for the best possible driving dynamics and precision steering performance. The front wheel drive has a compact construction with the engines integrated at a 90° angle so that no space is taken from the ample interior.

<sup>1</sup> Variable sport steering and Dynamic Damper Control not available for 225xe iPerformance.

## Safety.

Unparalleled safety with the latest BMW technology.

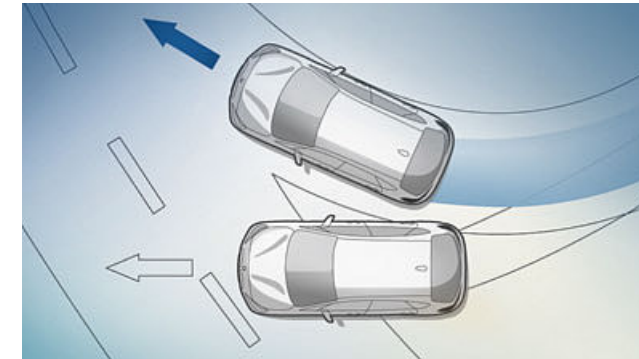

■ **Dynamic Stability Control (DSC)** constantly assesses the vehicle's movements and optimises directional stability and traction.

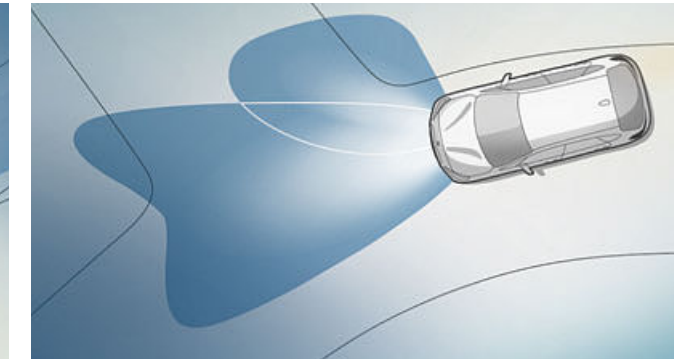

□ The **LED headlights with cornering lights** feature bright and efficient bi-LED light for low-beam and high-beam headlights. The LED cornering lights allow for adaptive light distribution with increased side illumination for urban driving.

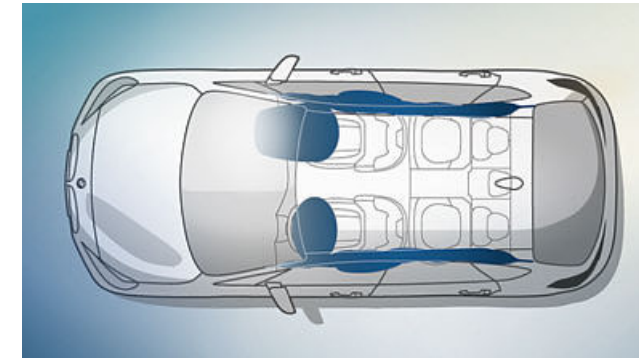

■ **Airbags for the driver and front passenger**, head airbags as well as side airbags integrated into the front seat backrests provide strategic protection.

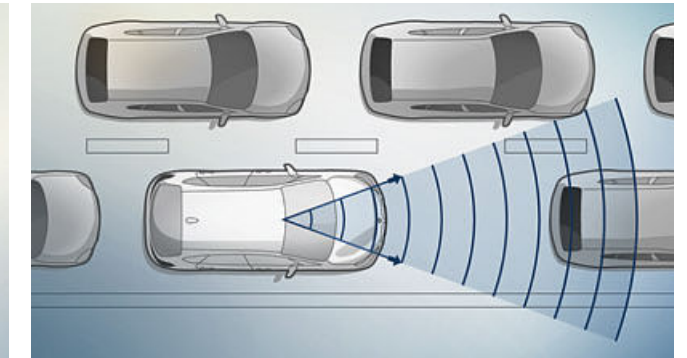

□ The **Traffic jam assistant**<sup>2</sup> controls the speed of the car and distance from the vehicle ahead in dense traffic on motorways at speeds of up to 60 km/h and provides steering assistance.

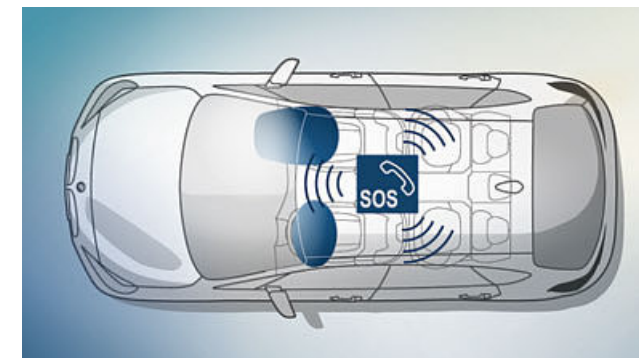

■ In emergency situations the **Intelligent emergency call**<sup>\*</sup> system automatically establishes a connection to the nearest rescue coordination centre via the BMW call centre – entirely independent of your own mobile phone. It transmits information regarding the vehicle's current location and the severity of the accident. The Intelligent emergency call can also be triggered manually.

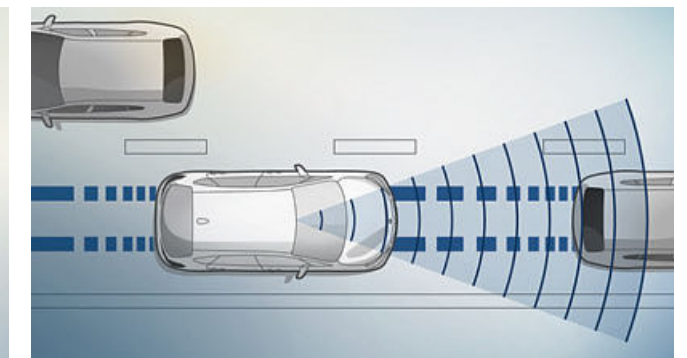

■ The **Approach control warning with light city braking function**<sup>3</sup> actively supports the driver in avoiding rear-end collisions or limiting their severity. Active at speeds of up to 60 km/h, it preconditions the brakes for faster responsiveness and even brakes automatically in the event of an emergency.

■ Standard equipment □ Optional equipment

<sup>2</sup> The Traffic jam assistant is part of the Driving Assistant Plus package. This system requires a Steptronic transmission.

<sup>3</sup> The functionality of the Approach control warning may be limited in darkness and fog.

\* May not be available in all countries. Please consult your BMW partner.

Optional and standard equipment vary according to country.





# INDIVIDUALITY AND CHOICE.

**EQUIPMENT:** BMW models, BMW Active Tourer with eDrive, equipment highlights, wheels and tyres as well as Original BMW Accessories.

**COLOURS:** Exterior and interior colour schemes.

**TECHNICAL DATA:** vehicle weight, engine, transmission, driving performance, consumption, wheels and technical drawings.

**BMW SERVICES:** BMW Service, BMW Financial Services and BMW Experience.

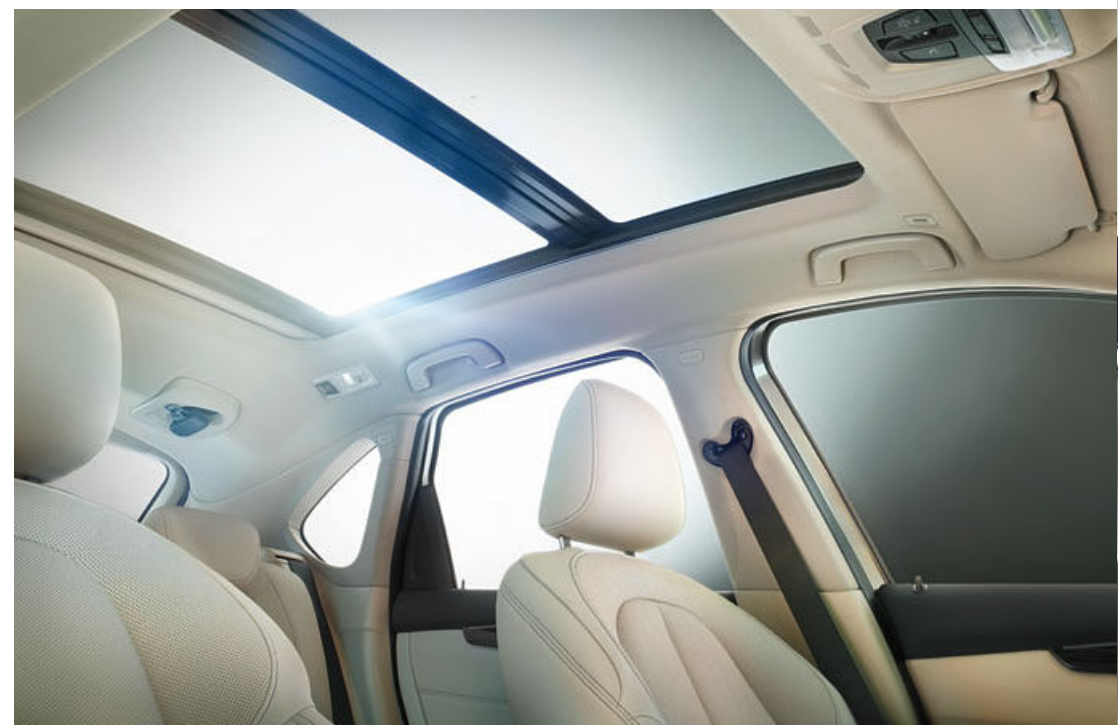

# BASIC.

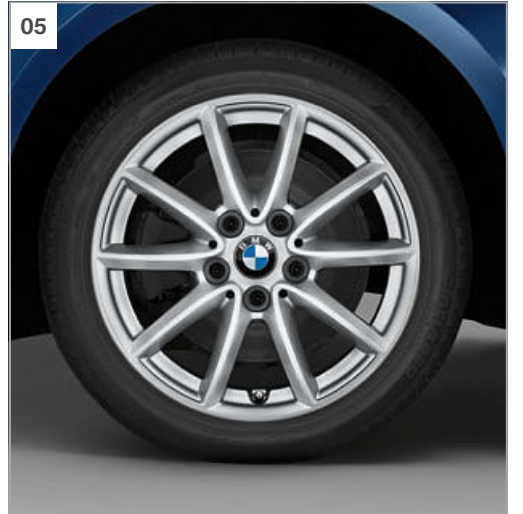

**[ 01 ]** The BMW 2 Series Active Tourer in the optional exterior colour Mediterranean Blue metallic with the optional 17" light alloy wheels V-spoke style 479 and the optional Chrome Line Exterior.

**[ 02 ]** Characteristic BMW interior design with a definite driver orientation and a modern aesthetic. Shown here with standard equipment including seats in cloth ,Grid' Anthracite and interior trim finishers Oxide Silver dark matt with highlight trim finisher Black high-gloss.

**[ 03 ]** The 218i Gran Tourer in the optional Imperial Blue brilliant effect paint finish with standard 16" light alloy wheels in V-spoke style 471 and the optional roof rails in Black.

**[ 05 ]** 16" light alloy wheels V-spoke style 471, 7 J x 16, 205/60 R 16 tyres.

**[ 04 ]** The seats in Anthracite Grid cloth lend the interior a sense of style and sophistication.

# LUXURY LINE.

■ Standard equipment □ Optional equipment

## Luxury Line interior equipment features:

- Front door sill finishers in Aluminium with BMW designation<sup>1</sup>
- Seats in leather 'Dakota' Black with exclusive perforations; other upholstery options are available
- Car key with Chrome detailing
- Interior trim finishers in fine-wood trim Finesline Stream with Pearl Chrome accents; other trim options are available
- Lighting package with LED technology and orange-white Ambient light
- Exclusive LED light strips in the door panels
- Instrument panel and centre console with contrast stitching (in colour of upholstery)
- Seat heating for driver and front passenger
- Sport leather steering wheel with multifunction buttons

## Luxury Line exterior equipment features:

- BMW kidney grille with twelve exclusively designed slats with Chrome high-gloss fronts
- Front bumper with characteristic design elements in Chrome high-gloss
- 17" light alloy wheels Multi-spoke style 481; other wheels are available
- Luxury Line designation on the side of the vehicle<sup>2</sup>
- Side window frames and window recess finishers in Aluminium anodised, mirror base and mirror foot in Black matt
- rear bumper with characteristic design elements in Chrome high-gloss

01 □



03 □



02 ■



04 □



**[ 01 ]** The light tones of the cockpit contrast with the optional dark interior fine-wood trim Finesline Shore, giving the interior a strikingly sophisticated look. The Sport leather steering wheel with multifunction buttons is a pleasure to hold.

**[ 02 ]** 17" light alloy wheels Multi-spoke style 481, 7.5 J x 17 with 205/55 R 17 tyres.

**[ 03 ]** The optional sport seats in leather 'Dakota' Canberra Beige with exclusive perforated leather upholstery, shown here, create a pleasant atmosphere in the interior (for other available leather colours see pages 52 | 53).

**[ 04 ]** 18" light alloy wheels Y-spoke style 484, 8 J x 18 with 225/45 R 18 tyres.

05 □



06 □



**[ 05 ]** The BMW 2 Series Active Tourer Luxury Line model in optional Platinum Silver metallic paint finish with optional LED headlights with cornering lights, the optional roof rails in Aluminium satinised and with the optional 18" light alloy wheels V-spoke style 485.

**[ 06 ]** The BMW 2 Series Gran Tourer Luxury Line model in optional Atlantic Grey metallic paint finish with optional 18" light alloy wheels V-spoke style 485 and optional roof rails in Aluminium satinised.

<sup>1</sup> For 225xe iPerformance with eDrive designation.

<sup>2</sup> Not available with the BMW 2 Series Active Tourer 225xe iPerformance.

## SPORT LINE.

■ Standard equipment □ Optional equipment

## Sport Line interior equipment:

- Front door sill finishers in Aluminium with BMW designation<sup>1</sup>
- Sport seats for driver and front passenger in cloth 'Race' Anthracite with Red highlights alternatively with Grey highlights; other upholstery options are available
- Car key with Chrome detailing
- Interior trim finishers in Black high-gloss with Pearl Chrome accents; other trim finisher options are available
- Lighting package with LED technology and orange – white Ambient light
- Exclusive LED light strips in the door panels
- Instrument panel and centre console with contrast stitching (in colour of upholstery)
- Seat heating for driver and front passenger
- Sport leather steering wheel including multifunction buttons

## Sport Line exterior equipment:

- BMW kidney grille with ten exclusively designed vertical slats with front sides in Black high-gloss
- Front bumper with specific design elements in Black high-gloss
- 17" light alloy wheels Star-spoke style 379, other wheels available
- "Sport Line" lettering on the side<sup>2</sup>
- Mirror caps in body colour, alternatively in Black
- Rear bumper with specific design elements in Black high-gloss



01 ■



03 ■



02 ■



04 ■

**[ 01 ]** The 2-zone automatic air conditioning lets driver and front passenger set separate preferred temperatures. The driver can also enjoy a high-grip Sport leather steering wheel with multifunction buttons (shown here with gearshift paddles) and cruise control with braking function.

**[ 02 ]** 17" light alloy wheels Star-spoke style 379, 7.5 J x 17 with 205/55 R 17 tyres.

**[ 03 ]** The sport seats in Anthracite Race cloth with red contrast stitching emphasises this model's sporty nature.

**[ 04 ]** "Sport Line" designation on the side of the vehicle.<sup>2</sup>

05 □



06 □



**[ 05 ]** The BMW 2 Series Active Tourer Sport Line model in optional Flamenco Red metallic paint finish with optional BMW Individual High-gloss Shadow Line, optional roof rails in Black and optional LED headlights with cornering lights and optional 18" light alloy wheels Y-spoke style 484.

**[ 06 ]** The BMW 2 Series Gran Tourer Sport Line model in optional Mineral White metallic paint finish with optional roof rails in Black, the optional BMW Individual High-gloss Shadow Line as well as the optional 17" light alloy wheels Star-spoke style 379.

<sup>1</sup> For 225xe iPerformance with eDrive designation.

<sup>2</sup> Not available with the BMW 2 Series Active Tourer 225xe iPerformance.

# M SPORT PACKAGE.

powered by 

■ Standard equipment □ Optional equipment

## M Sport package interior equipment:

- M door sill finishers<sup>1</sup> front, M driver footrest
- Sport seats for driver and front passenger in Cloth /Alcantara combination 'Micro Hexagon' Anthracite<sup>1</sup> in exclusive M look, alternatively
- Sport seats for driver and front passenger in Leather 'Dakota' Black with perforations and with Blue accent, other upholsteries available
- M Leather steering wheel with multifunction buttons
- BMW Individual headliner anthracite
- Dashboard and centre console with contrast stitching
- Interior trim finishers in Aluminium Hexagon, other trims available
- Shortened gear lever with M logo
- Lighting package with LED technology and orange – white Ambient light
- Exclusive LED optical fibre in the door trim
- Car key with exclusive M logo

## M Sport package exterior equipment:

- M Aerodynamics package with front apron, side skirts and rear apron with diffuser insert in Dark Shadow metallic
- BMW kidney grille with ten exclusively designed vertical slats with front sides in Black high-gloss
- 17" M light alloy wheels Double-spoke style 483 M, alternatively
- 18" M light alloy wheels Double-spoke style 486 M
- M Sport suspension, lowered<sup>1</sup>, alternatively Standard running gear
- BMW Individual high-gloss Shadow Line
- M logo on the sides
- Exclusive paintwork in Estoril Blue metallic, other paintworks available

01 ■



02 ■



**[ 01 ]** The M leather steering wheel with multifunction buttons together with the interior trim finishers Aluminium Hexagon lend the interior a distinctly sporty look (shown here with gearshift paddles).

**[ 02 ]** BMW Individual headliner in Anthracite.

**[ 03 ]** The standard sport seats in cloth Hexagon/Alcantara emphasise the interior's dynamic appearance.

03 ■



04 ■



05 □



**[ 04 ]** 17" M light alloy wheels Double-spoke style 483 M, 7.5J x 17 with 205/55 R17 tyres.

**[ 05 ]** 18" M light alloy wheels Double-spoke style 486 M, 8J x 18 with 225/45 R18 tyres.

06 □



07 □



**[ 06 ]** The BMW 2 Series Active Tourer with the M Sport package with the optional Estoril Blue metallic paint finish, available exclusively for the M Sport package, as well as the optional roof rails in Black, the optional LED headlights with cornering lights and the optional 18" M light alloy wheels Double-spoke style 486 M.

**[ 07 ]** The BMW 2 Series Gran Tourer with M Sport package in optional exclusive Estoril Blue metallic paint finish with optional roof rails in Black and optional 18" M light alloy wheels Double-spoke style 486 M.

<sup>1</sup> Not available with the BMW 2 Series Active Tourer 225xe iPerformance.

## THE BMW 2 SERIES ACTIVE TOURER PLUG-IN HYBRID.

**iPERFORMANCE**

The BMW 2 Series Active Tourer 225xe iPerformance is a plug-in hybrid combining a BMW TwinPower Turbo 3-cylinder petrol engine with 100 kW (136 hp) and a 65 kW (88 hp) electric motor for a total system output of 165 kW (224 hp). The standard electric xDrive provides optimum traction and reliable directional stability, 100% automatically. The intelligent energy management system coordinates the interaction of all BMW drive components. Depending on the battery's charging status and the drive mode selected, the electric motor can drive the vehicle by itself, or support the internal combustion engine. When coasting or braking it even transforms the vehicle's kinetic energy into electric energy that is fed back into the battery for electric drive. On electrical power alone the vehicle can achieve a range of up to 41 km and an electric top speed of 125 km/h. Combined consumption amounts to 2.0–2.1 l/100 km<sup>1</sup>, causing CO<sub>2</sub> emissions of 46–49 g/km<sup>1</sup>. At home, the vehicle can be charged from a standard domestic power socket or even more conveniently from the BMW i Wallbox. On the road, this BMW can be charged at public charging stations.

■ Standard equipment □ Optional equipment

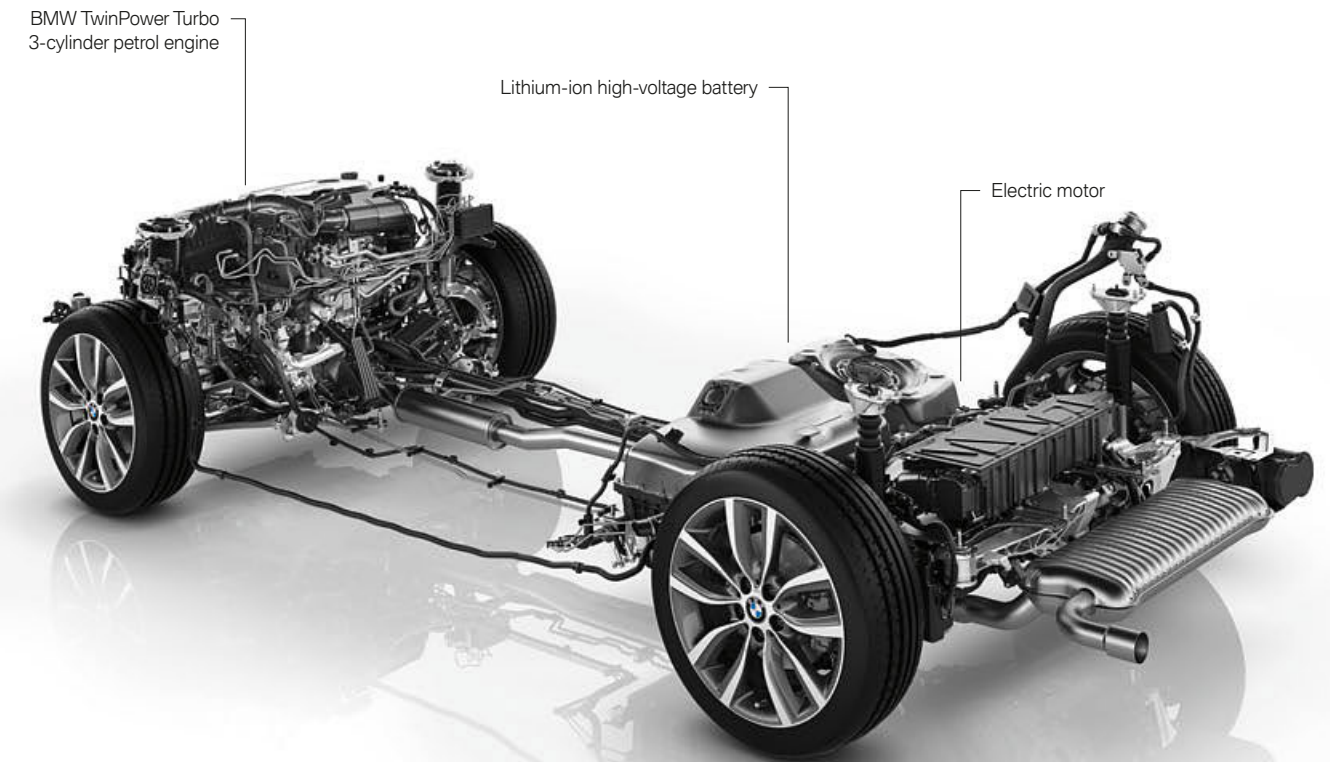

**[ 01 ]** The eDrive button allows the driver to choose between three electric drive modes: AUTO eDrive (standard), MAX eDrive or SAVE BATTERY.

**[ 03 ]** The charging port for the external charging of the high-voltage battery is located behind a flap on the vehicle's front left side panel. A special sealing ring protects the plug from the elements.

**[ 05 ]** Luggage compartment with a flat floor, beneath which the electric motor, including its power electronics, is stored. The rear seat backrest, which can be divided in a 40:20:40 split, ensures great flexibility.

**[ 02 ]** The special instrument cluster includes various displays that help the driver to deploy the electric drive as efficiently as possible. The eDrive designation in the instrument panel calls attention to the vehicle's highly efficient drive concept.

**[ 04 ]** The BMW TwinPower Turbo 3-cylinder petrol engine is notable for its agile power delivery, spontaneous responsiveness – even at low engine speeds – along with a stirring sound and high efficiency. In the plug-in hybrid, it proves itself to be a powerful drive unit in conjunction with the electric motor.

**[ 06 ]** Special door sill finishers with blue detailing and the eDrive designation in the doors calls attention to the vehicle's highly efficient drive concept.<sup>2</sup>

The BMW 2 Series Active Tourer 225xe iPerformance in the Luxury Line, shown with the following optional equipment: exterior colour Glacier Silver metallic, roof rails Aluminium satinised, LED headlights with cornering light and 18" light alloy wheels V-spoke style 485.

<sup>1</sup> Consumption figures are affected by tyre dimensions and the optional equipment selected. Further information on fuel consumption and CO<sub>2</sub> emissions can be found on pages 54 | 55 or consult your BMW partner.

<sup>2</sup> Not available with the 225xe iPerformance M Sport package.

## EQUIPMENT HIGHLIGHTS.

■ Standard equipment □ Optional equipment



**[ 01 ]** LED headlights with cornering lights feature bright daylight-spectrum light for low-beam and high-beam.

**[ 02 ]** BMW Individual High-gloss Shadow Line: side frame, window recess finishers, mirror base, mirror foot and exterior mirror frames in Black high-gloss.

**[ 03 ]** With the Chrome Line Exterior the windows are fully framed in Chrome.

**[ 04 ]** The LED daytime driving lights and position lights in the main headlights' light tubes create an unmistakable appearance (part of the LED headlights).

**[ 05 ]** Fog lights in the front apron, heated exterior mirrors and windscreen washer jets together provide better visibility and increase safety. These are standard equipment for all model variants.<sup>1</sup>

**[ 06 ]** Panorama glass roof, electric, with slide and lift functions (front), roller sunblind, a wind deflector and comfort opening function via the remote control.



**[ 07 ]** The steering wheel heating quickly warms up the rim of the steering wheel at the push of a button – a comfort feature which is especially pleasant in winter.

**[ 08 ]** The Black Sport leather steering wheel with a thick rim and contoured thumb rests has an exceptionally pleasant, high-grip feel (shown here with optional multifunction buttons and gearshift paddles).

**[ 09 ]** The 8-speed automatic Steptronic Sport transmission allows for both comfortable coasting and a dynamic driving style.<sup>2</sup>

**[ 10 ]** The M leather steering wheel features multifunction buttons, a steering wheel rim in leather 'Walknappa' Black and contoured thumb rests (shown here with optional gearshift paddles).

**[ 11 ]** Driving Experience Control enables the driver to choose between comfortable, particularly efficient, or especially sporty driving.

**[ 12 ]** The electric parking brake is conveniently activated via a button in the centre console. The absence of a brake lever provides more room for storage.

<sup>1</sup> Standard for BMW 2 Series Active Tourer 225i, 225i xDrive, 220d, 220d xDrive and 225xe iPerformance and standard for the BMW 2 Series Gran Tourer 220d and 220d xDrive.  
<sup>2</sup> Not available for the 216i, 218i and 216d.

## EQUIPMENT HIGHLIGHTS.

■ Standard equipment □ Optional equipment



**[ 01 ]** Park Distance Control (PDC) at the rear makes it easier to reverse and park the car in tight spaces.

**[ 04 ]** The Parking assistant makes parallel parking easier. It does the steering while the driver remains in control of the accelerator and brake (part of the Park Distance Control, front and rear option).

**[ 02 ]** Driving Assistant Plus offers warning and anti-collision functions, the camera-based Cruise Control and the Traffic jam assistant.<sup>1</sup>

**[ 05 ]** The Rear view camera shows the area behind the car on the Control Display. Interactive track lines and markings showing obstacles also assist the driver.

**[ 03 ]** The full-colour BMW Head-Up Display projects all relevant information onto a screen positioned within the driver's field of vision.<sup>2</sup>

**[ 06 ]** Navigation Plus including BMW Head-Up Display, iDrive Touch Controller and built-in 8.8" LCD colour display. Optional RTTI equipment shown here.

**[ 07 ]** Convenience telephony with extended smartphone connectivity incl. microphone for passenger side. Two mobile phones and one audio player can be linked simultaneously via Bluetooth. Connection to the external aerial via a separate snap-in adapter.<sup>3</sup>

**[ 08 ]** Harman Kardon Surround Sound System with 360 W digital amplifier, 7 channels and 12 loudspeakers, including centre speaker.

**[ 09 ]** Passengers can place and use various objects on the folding tables at the rear. Their height can be adjusted.

**[ 10 ]** The passenger seat with foldable backrest typifies the well-thought-out concept's flexible usage of space.<sup>4</sup>

**[ 11 ]** The tailgate can be opened and closed simply by waving your foot below the rear bumper.<sup>5</sup>

**[ 12 ]** The third row of seats includes two individual fold-down seats facing the direction of travel. To facilitate entry, the second row of seats can be folded down using the Easy Entry Function (only in the BMW 2 Series Gran Tourer).

**[ 13 ]** The adjustable rear seat allows even more versatile use of the luggage compartment. The seats can be adjusted to either increase leg room for the rear passengers or to maximise loading space in the luggage compartment, as required (standard for BMW 2 Series Gran Tourer).

**[ 14 ]** With the remote electric rear backrest release the rear backrest can be folded down conveniently from the luggage compartment (standard for the BMW 2 Series Gran Tourer. Not available for the 225xe).

**[ 15 ]** The automatic tailgate operation electronically opens and closes the tailgate: simply press a button.

**[ 16 ]** The 40:20:40 split-folding rear seat bench makes loading even easier, and the vehicle even more versatile. The angle of the rear seat backrest can also be adjusted.<sup>6</sup>

<sup>1</sup> Only available in conjunction with Steptronic transmission and Navigation or Navigation Plus.

<sup>2</sup> BMW Head-Up Display only available in conjunction with the optional equipment Navigation Plus. The information displayed is not fully visible when wearing polarised sunglasses. The exact content shown on the BMW Head-Up Display will depend on the equipment options chosen. Further optional equipment is required for content to be displayed.

<sup>3</sup> Snap-in adapter with charging function and interface for USB playback available from BMW Original Accessories.

<sup>4</sup> Foldable backrest not available in conjunction with Sport seats and electric seat adjustment with memory function.

<sup>5</sup> Only available in conjunction with Automatic tailgate operation and the Comfort access system.

<sup>6</sup> Optionally available for the BMW 2 Series Active Tourer.

Optional and standard equipment vary according to country.



## WHEELS AND TYRES.

■ Standard equipment □ Optional equipment ○ Accessories



**[ 01 ]** 18" light alloy wheels V-spoke style 485, 8J x 18, with 225/45 R18 tyres.

**[ 04 ]** 18" light alloy wheels Y-spoke style 484, 8 J x 18 with 225/45 R 18 tyres.

**[ 08 ]** 17" light alloy wheels Y-spoke style 480, 7.5J x 17 with 205/55 R17 tyres.

**[ 02 ]** 17" light alloy wheels Double-spoke style 385, 7.5J x 17, with 205/55 R17 tyres.<sup>1</sup>

**[ 05 ]** 17" light alloy wheels V-spoke style 479, 7.5J x 17, 205/55 R17 tyres.<sup>3</sup>

**[ 09 ]** 17" light alloy wheels Star-spoke style 478, 7.5 J x 17 with 205/55 R 17 tyres.

**[ 03 ]** 16" light alloy wheels V-spoke style 471, 7J x 16 with 205/60 R16 tyres.<sup>2</sup>

**[ 06 ]** 16" light alloy wheels Double-spoke style 473, 7 J x 16 with 205/60 R 16 tyres.

**[ 10 ]** 16" light alloy wheels Turbine style 472, 7 J x 16 with 205/60 R 16 tyres.

**[ 07 ]** 18" light alloy wheels Double-spoke style 361 in bi-colour Orbit Grey, gloss-lathed, 8J x 18 with 225/45 R18 tyres.<sup>4</sup>

**[ 11 ]** 19" light alloy wheels turbine styling 487 in Bicolor Ferric Grey, gloss-lathed, 8J x 19 with 225/40 R19 tyres.<sup>3</sup>

<sup>1</sup> Standard for the BMW 2 Series Active Tourer 225i, 225i xDrive.

<sup>2</sup> Standard for the BMW 2 Series Active Tourer 216i, 218i, 220i, 216d, 218d, 218d xDrive, 220d, 220d xDrive and for the BMW 2 Series Gran Tourer 216i, 218i, 216d, 218d and 218d xDrive.

<sup>3</sup> Standard for BMW 2 Series Gran Tourer 220i, 220d, 220d xDrive and BMW 2 Active Tourer 225xe iPerformance.

<sup>4</sup> These wheel designs and more can be found under Original BMW Accessories at [www.bmw.com/accessories](http://www.bmw.com/accessories)

## ORIGINAL BMW ACCESSORIES.

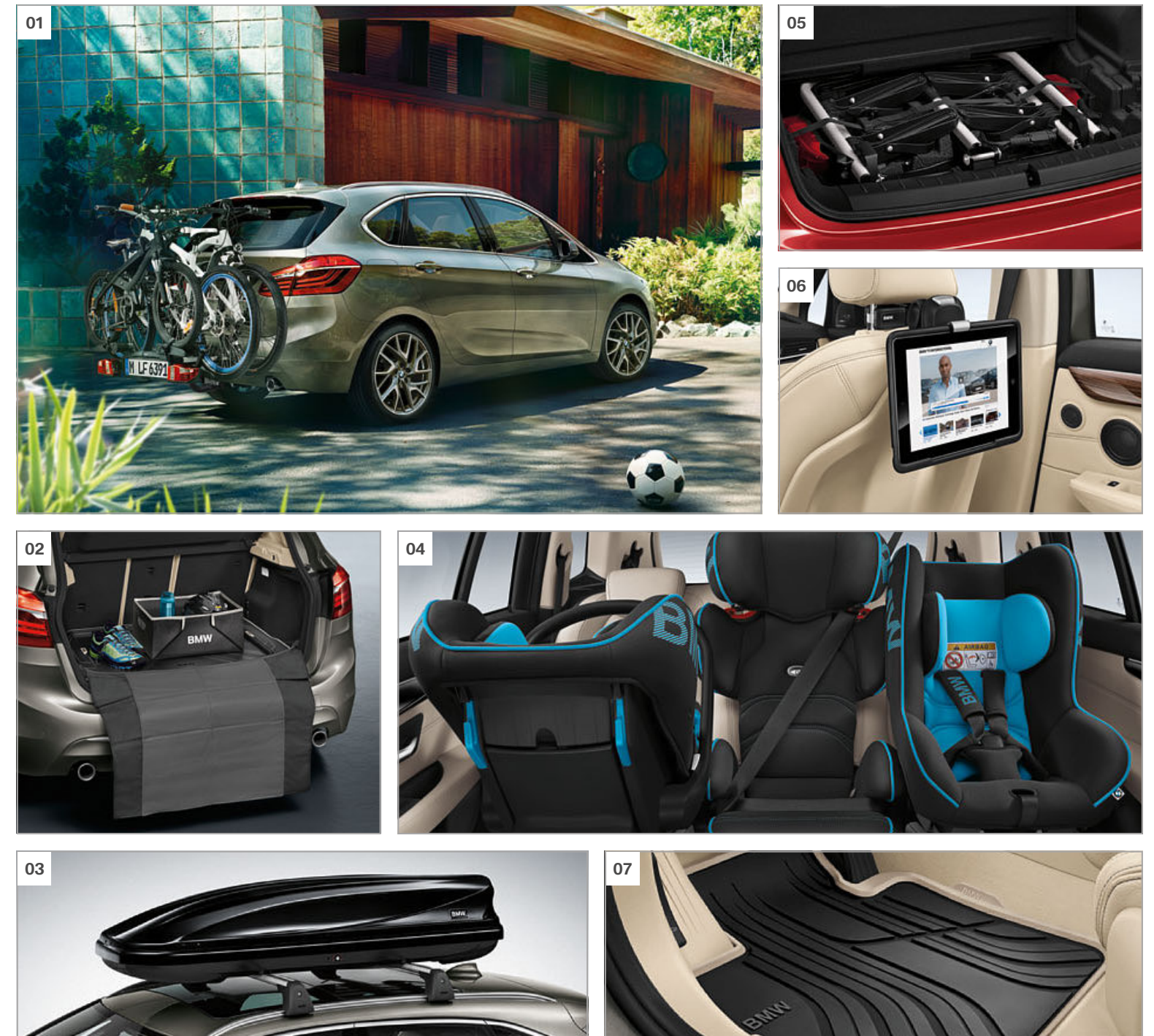

**[ 01 ]** Bicycle / e-bike holder for the transport of up to three bikes (max. 60 kg), extension for third bike available. Securely mounts to the trailer tow hitch. Tilting function for easy access to the luggage compartment.

**[ 02 ]** Luggage compartment mat to protect the luggage compartment from dirt and moisture. With raised border and two textile pockets. Available in Anthracite, Anthracite/red and Anthracite/beige (shown with folding box and loading sill mat).

**[ 03 ]** BMW roof box 320 for up to five pairs of skis.

Compatible with all BMW roof rack systems. With double-sided opening system and triple locking on each side.

**[ 04 ]** BMW child seats available in various models and colours (three BMW child seats can only be fitted in the second row of seating in the BMW 2 Series Gran Tourer).

**[ 05 ]** Compact rear bike rack. For two bicycles or electric bicycles (each weighing no more than 30 kg). Can be easily and safely mounted on the trailer tow hitch, and safely folded up and stowed in the luggage compartment tray.

**[ 06 ]** Travel & Comfort System – iPad holder. Snapped into the basic carrier and securely holds any Apple iPad™.

**[ 07 ]** All-weather floor mats.

Optional and standard equipment vary according to country.

Discover the wide range of innovative solutions in the following categories: exterior, interior, communication & information as well as transport & luggage solutions. Your BMW partner will be happy to advise you and provide you with a special catalogue detailing the entire range of Original BMW Accessories. For more information visit [www.bmw.com/accessories](http://www.bmw.com/accessories)

# EXTERIOR COLOURS.

■ Standard equipment □ Optional equipment



■ Non-metallic 668 Black



□ Metallic A83 Glacier Silver<sup>2</sup>



□ Metallic B39 Mineral Grey<sup>2</sup>

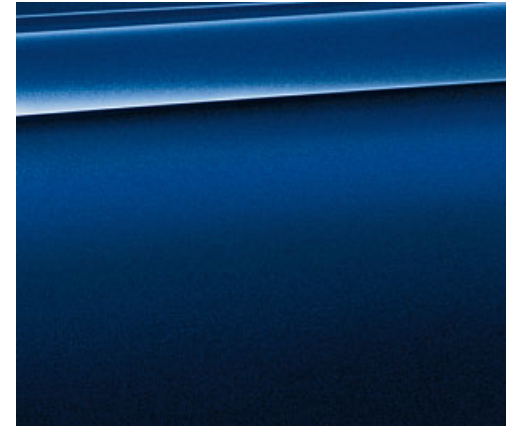

□ Metallic C10 Mediterranean Blue



□ Metallic B45 Estoril Blue<sup>3</sup>

## M SPORT PACKAGE



□ Non-metallic 300 Alpine White<sup>1</sup>

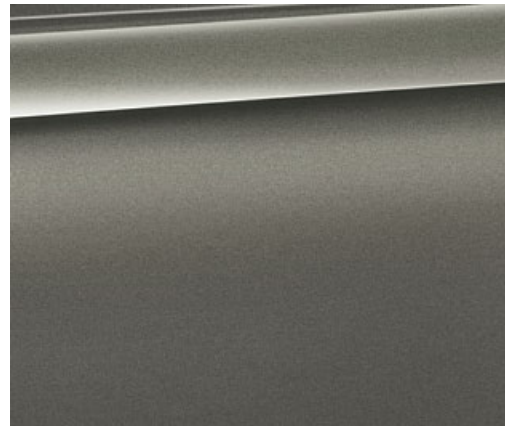

□ Metallic C08 Platinum Silver



□ Metallic C06 Flamenco Red brilliant effect



□ Metallic A89 Imperial Blue brilliant effect



□ Metallic A96 Mineral White<sup>2</sup>



□ Metallic C09 Atlantic Grey



□ Metallic B53 Sparkling Brown



□ Metallic 475 Black Sapphire<sup>2</sup>

<sup>1</sup> Standard with the M Sport package.  
<sup>2</sup> Optionally available with the M Sport package.  
<sup>3</sup> Exclusively available with the M Sport package.

Optional and standard equipment vary according to country.

**[Colour samples]** These colour samples are intended as an initial guide to the colours and materials available for your BMW. However, experience has shown that printed versions of paint, upholstery and interior trim colours cannot in all cases faithfully reproduce the appearance of the original colour. Please discuss your preferred colour choices with your BMW partner or dealership. There you can also see original samples and be assisted with special requests.

# INTERIOR COLOURS.

■ Standard equipment □ Optional equipment



## CLOTH

Cloth	Available with	Description
	■ Basic	Cloth 'Grid' <sup>1</sup> EGAT Anthracite <sup>1</sup>
	■ Sport Line	Cloth 'Race' <sup>2</sup> ERL2 Anthracite, Red highlights <sup>2</sup>
	□ Basic □ Sport Line	Race cloth ERL1 Anthracite with grey highlights <sup>2</sup>

## LEATHER

Leather	Available with	Description
	□ Basic	Dakota leather LCSW Black
	□ Basic	Dakota leather LCCY Canberra Beige
	□ Luxury Line □ Sport Line □ M Sport package	Dakota leather PDCY Canberra Beige, perforated, with grey highlights
	■ Luxury Line □ Sport Line □ M Sport package	Dakota leather PDSW Black, perforated, with grey highlights

## CLOTH/LEATHER COMBINATION

Combination	Available with	Description
	■ M Sport package	Cloth/Alcantara combination 'Hexagon' <sup>3</sup> HMAT Anthracite <sup>3</sup>

Leather	Available with	Description
	□ Sport Line	Dakota leather PDL3 Black, perforated, with red highlights
	□ M Sport package	Leather 'Dakota' PDN4 Black, perforated, Blue highlights <sup>4</sup>
	□ Luxury Line □ Sport Line □ M Sport package	Dakota leather PDOA Oyster, perforated, with grey highlights
	□ Luxury Line □ Sport Line □ M Sport package	Dakota leather PDD3 Saddle Brown, perforated, with grey highlights

## INTERIOR TRIMS

Trim	Available with	Description
	■ Basic	4FS Oxide Silver dark, matt, with Black high-gloss accent line
	□ Basic □ Luxury Line □ Sport Line □ M Sport package	4LS Fine Brushed Aluminium with Pearl- Gloss Chrome accent line
	□ Basic ■ Luxury Line □ Sport Line □ M Sport package	4LR Finition Stream fine- wood trim with Pearl-Gloss Chrome accent line
	□ Basic □ Luxury Line ■ Sport Line □ M Sport package	4LU High Gloss Black with Pearl-Gloss Chrome accent line
	□ Luxury Line □ Sport Line	4FZ Finition Tide fine- wood trim with Pearl-Gloss Chrome accent line
	□ Luxury Line	4FY Finition Shore fine-wood trim with inlays, with Pearl-Gloss Chrome accent line
	■ M Sport package	4WE Aluminium Hexagon with Pearl-Gloss Chrome accent line

## INTERIOR COLOURS

Colour	Available with	Description
	■ Basic ■ Luxury Line ■ Sport Line ■ M Sport package	Black
	□ Basic □ Luxury Line □ Sport Line □ M Sport package	Canberra Beige

## HEADLINER

Headliner	Available with	Description
	□ Basic □ Luxury Line □ Sport Line ■ M Sport package	BMW Individual headliner 775 Anthracite

Please note that even normal long or short-term use can lead to unrecoverable upholstery damage. This can be caused in particular by non-colourfast clothing.

Please note that the interior colour depends on the selected upholstery colour.

<sup>1</sup> Not available in conjunction with sport seats.  
<sup>2</sup> Only available in conjunction with sport seats.

<sup>3</sup> Not available for 225xe iPerformance.  
<sup>4</sup> Standard for 225xe iPerformance.

Optional and standard equipment vary according to country.

2 Series Active Tourer	216i	218i	220i	225i 225i xDrive	216d	218d 218d xDrive	220d 220d xDrive	225xe iPerformance
------------------------	------	------	------	---------------------	------	---------------------	---------------------	-----------------------

Weight/volume									
Unladen weight EU <sup>1</sup>	kg	1415	1415 [1445]	1475 [1505]	[1505]	1440 [1470]	1450 [1485]	1480 [1505]	-
Unladen weight EU <sup>1</sup> (xDrive)	kg	-	-	-	[1585]	-	1540 [1560]	[1585]	[1735]
Max. permissible	kg	1885	1890 [1920]	1940 [1970]	[1980]	1925 [1935]	1935 [1965]	1965 [1985]	-
Max. permissible weight (xDrive)	kg	-	-	-	[2055]	-	2020 [2040]	[2050]	[2180]
Permitted load	kg	525	525 [525]	525 [525]	[525]	525 [525]	525 [525]	525 [525]	-
Permitted load (xDrive)	kg	-	-	-	[525]	-	525 [525]	[515]	[515]
Permitted trailer load, unbraked <sup>2</sup>	kg	695	695 [695]	730 [730]	[750]	705 [705]	725 [725]	735 [735]	-
Permitted trailer load, unbraked (xDrive) <sup>2</sup>	kg	-	-	-	[750]	-	750 [750]	[750]	-
Permitted trailer load, braked, max. 12% gradient / 8% gradient <sup>2</sup>	kg	1100/1100	1300/1300 [1300/1300]	1500/1500 [1500/1500]	[1500/1500]	1300/1300 [1300/1300]	1300/1300 [1300/1300]	1500/1500 [1500/1500]	-
Permitted trailer load, braked, max. 12% gradient / 8% gradient (xDrive) <sup>2</sup>	kg	-	-	-	[1600/1600]	-	1600/1600 [1600/1600]	[1600/1600]	-
Luggage compartment capacity, seats unfolded/folded	l	468/1510	468/1510	468/1510	468/1510	468/1510	468/1510	468/1510	400/1350

Engine <sup>3,4</sup>									
Cylinders/valves		3/4	3/4	4/4	4/4	3/4	4/4	4/4	3/4
Capacity	cc	1499	1499	1998	1998	1496	1995	1995	1499
Max. output/engine speed	kW (hp/rpm)	75 (102)/4100	100 (136)/4400	141 (192)/ 5000-6000	170 (231)/5000	85 (116)/4000	110 (150)/4000	140 (190)/4000	100 (136)/4400
Max. torque/engine speed	(Nm/rpm)	180/1200-3800	220/1250	280/1250-4600	350/1250	270/1750	330/1750-2750	400/1750	220/1250-4300

Power delivery									
Drive configuration		Front wheel	Front wheel	Front wheel	Front wheel/ four-wheel	Front wheel	Front wheel/ four-wheel	Front wheel/ four-wheel	Electric four-wheel
Standard transmission		6-speed manual	6-speed manual	6-speed manual	8-speed Steptronic	6-speed manual	6-speed manual	6-speed manual	-
Standard transmission (xDrive)		-	-	-	8-speed Steptronic	-	6-speed manual	8-speed Steptronic	6-speed Steptronic

Performance									
Top speed	km/h	188	205 [205]	230 [228]	[238]	195 [195]	208 [210]	227 [224]	-
Top speed (xDrive)	km/h	-	-	-	[235]	-	208 [208]	[222]	[202]
Electric top speed	km/h	-	-	-	-	-	-	-	[125]
Acceleration 0-100 km/h	s	11.4	9.3 [9.2]	7.5 [7.4]	[6.6]	10.6 [10.6]	8.9 [8.9]	7.6 [7.5]	-
Acceleration 0-100 (xDrive) km/h	s	-	-	-	[6.3]	-	8.6 [8.8]	[7.3]	[6.7]

Fuel consumption <sup>3,5</sup>									
Urban	l/100 km	6.7-6.9	6.3-6.5 [6.3-6.5]	7.7-8.0 [7.0-7.2]	[7.3-7.5]	4.4-4.6 [4.4-4.7]	4.8-5.1 [4.7-4.9]	5.2-5.3 [4.8-5.0]	-
Urban (xDrive)	l/100 km	-	-	-	[8.1-8.3]	-	5.8-6.0 [5.2-5.4]	5.3-5.5	-
Extra-urban	l/100 km	4.6-4.9	4.5-4.6 [4.4-4.6]	4.8-5.0 [4.8-4.9]	[4.9-5.1]	3.4-3.6 [3.6-3.8]	3.7-3.9 [3.8-4.0]	3.9-4.1 [4.0-4.1]	-
Extra-urban (xDrive)	l/100 km	-	-	-	[5.4-5.5]	-	4.1-4.3 [4.3-4.5]	[4.4-4.6]	-
Combined	l/100 km	5.4-5.6	5.1-5.3 [5.1-5.3]	5.9-6.1 [5.6-5.8]	[5.8-6.0]	3.8-3.9 [3.9-4.1]	4.1-4.3 [4.1-4.3]	4.4-4.5 [4.3-4.4]	-
Combined (xDrive)	l/100 km	-	-	-	[6.4-6.5]	-	4.7-4.9 [4.6-4.8]	[4.7-4.9]	[2.0-2.1]
Electricity consumption <sup>6</sup>	kWh/100 km	-	-	-	-	-	-	-	[11.8-11.9]
Combined CO <sub>2</sub> emissions	g/km	123-128	119-124 [119-124]	137-142 [130-134]	[135-139]	99-104 [103-108]	109-114 [109-114]	115-119 [113-117]	-
Combined CO <sub>2</sub> emissions (xDrive)	g/km	-	-	-	[148-152]	-	124-129 [122-127]	[124-129]	[46-49]
Tank capacity approx.	l	51	51	51	61	51	51	51	36

Wheels/tyres									
Tyre dimensions		205/60 R16 V	205/60 R16 V	205/60 R16 V	205/55 R17 W	205/60 R16 V	205/60 R16 V	205/60 R16 V	205/55 R17 W
Wheel dimensions		7J x 16	7J x 16	7J x 16	7.5J x 17	7J x 16	7J x 16	7J x 16	7.5J x 17
Material		light alloy	light alloy	light alloy	light alloy	light alloy	light alloy	light alloy	light alloy

2 Series Active Tourer	216i	218i	220i	225i 225i xDrive	216d	218d 218d xDrive	220d 220d xDrive	225xe iPerformance
------------------------	------	------	------	---------------------	------	---------------------	---------------------	-----------------------

eDrive system output									
Peak performance/engine speed	kW (hp/rpm)	-	-	-	-	-	-	-	65 (88)/4000
System performance	kW (hp)	-	-	-	-	-	-	-	165 (224)
System torque	Nm	-	-	-	-	-	-	-	385

Capacity high-voltage battery									
Battery type/net battery capacity	kWh	-	-	-	-	-	-	-	Li-Ion/5.7
Electric range (NEFZ) <sup>7</sup> / Max. combined total range <sup>8</sup>	km	-	-	-	-	-	-	-	41/550
Charging time <sup>7</sup> (with standard wall socket/BMW i Wallbox Pure/Pro)	h	-	-	-	-	-	-	-	3.15/-/-

<sup>1</sup> The figure quoted includes a 90% full tank, 68 kg for the driver and 7 kg for luggage. Unladen weight applies to vehicles with standard equipment. Optional equipment will increase this figure.

<sup>2</sup> The actual overall trailer weight may not exceed the max. permitted trailer load, while taking into account the max. permitted tow bar download.

<sup>3</sup> BMW recommends the use of RON 95 super unleaded petrol. Unleaded fuels RON 91 and higher with a maximum ethanol percentage of 10% may also be used. Output and fuel consumption figures apply to 98 RON fuel.

<sup>4</sup> All engines comply with the EU6 emissions standard. Fuel consumption figures are determined according to the ECE driving cycle, which consists of approximately one-third urban traffic and two-thirds extra-urban driving (based on the distance covered). CO<sub>2</sub> emissions are measured in addition to fuel consumption.

<sup>5</sup> Fuel consumption, CO<sub>2</sub> emissions and energy efficiency classifications are affected by the selected wheel and tyre sizes. Please consult your local BMW partner for more detailed information.

<sup>6</sup> Range and electricity consumption are dependent on various factors, especially personal driving style, road conditions, exterior temperature, heating/air conditioning and cabin pre-conditioning.

<sup>7</sup> Dependent on local electricity infrastructure. The recharging time is for charging the car to 100% of maximum capacity.

<sup>8</sup> Values in [ ] refer to vehicles with Steptronic transmission.

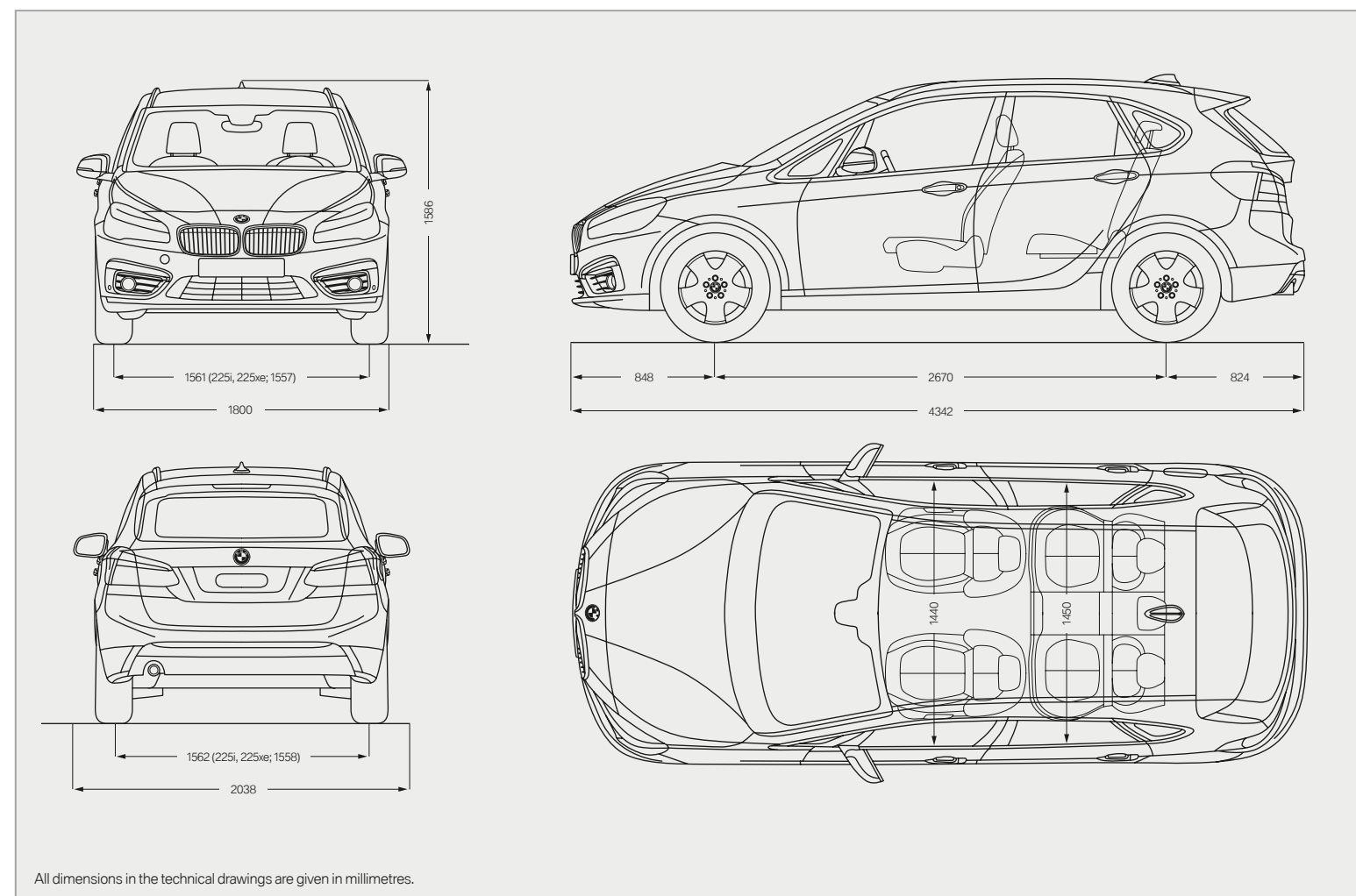

All dimensions in the technical drawings are given in millimetres.

2 Series Gran Tourer		216i	218i	220i	216d	218d 218d xDrive	220d 220d xDrive
----------------------	--	------	------	------	------	---------------------	---------------------

Weight/volume							
Unladen weight EU <sup>1</sup>	kg	1475	1470 [1500]	1530 [1570]	1495 [1505]	1525 [1555]	1550 [1570]
Unladen weight EU <sup>1</sup> (xDrive)	kg	-	-	-	-	1605 [1615]	[1640]
Max. permissible	kg	2040	2040 [2065]	2100 [2130]	2070 [2090]	2090 [2120]	2120 [2140]
Max. permissible weight (xDrive)	kg	-	-	-	-	2175 [2195]	[2210]
Permitted load	kg	600	600 [600]	600 [600]	600 [600]	600 [600]	600 [600]
Permitted load/xDrive	kg	-	-	-	-	600 [600]	600 [600]
Permitted trailer load, unbraked <sup>2</sup>	kg	730	735 [735]	750 [750]	745 [745]	750 [750]	750 [750]
Permitted trailer load, unbraked (xDrive) <sup>2</sup>	kg	-	-	-	-	750 [750]	750 [750]
Permitted trailer load, braked, max. 12% gradient / 8% gradient <sup>2</sup>	kg	1100/1100	1500/1500 [1500/1500]	1500/1500 [1500/1500]	1500/1500 [1500/1500]	1500/1500 [1500/1500]	1500/1500 [1500/1500]
Permitted trailer load, braked, max. 12% gradient / 8% gradient (xDrive) <sup>2</sup>	kg	-	-	-	-	1600/1600 [1600/1600]	1600/1600 [1600/1600]
Luggage compartment capacity, seats unfolded/folded <sup>3</sup>	l	645-805/1905	645-805/1905	645-805/1905	645-805/1905	645-805/1905	645-805/1905
Luggage compartment capacity, incl. 3. row of seats, seats unfolded/folded <sup>3</sup>	l	560-720/1820	560-720/1820	560-720/1820	560-720/1820	560-720/1820	560-720/1820

Engine <sup>4,5</sup>							
Cylinders/valves		3/4	3/4	4/4	3/4	4/4	4/4
Capacity	cc	1499	1499	1998	1496	1995	1995
Max. output/engine speed	kW (hp/rpm)	75 (102)/4100	100 (136)/4400	141 (192)/ 5000-6000	85 (116)/4000	110 (150)/4000	140 (190)/4000
Max. torque/engine speed	(Nm/rpm)	180/1200	220/1250	280/1250-4600	270/1750	330/1750-2750	400/1750-2500

Power delivery							
Drive configuration		Front wheel	Front wheel	Front wheel	Front wheel	Front wheel/four-wheel	Front wheel/four-wheel
Standard transmission		6-speed manual	6-speed manual	6-speed manual	6-speed manual	6-speed manual	6-speed manual
Standard transmission (xDrive)		-	-	-	-	6-speed manual	8-speed Steptronic

Performance							
Top speed	km/h	185	205 [203]	223 [221]	192 [192]	205 [207]	222 [220]
Top speed (xDrive)	km/h	-	-	-	-	205 [205]	[218]
Acceleration 0-100 km/h	s	11.9	9.5 [9.5]	7.7 [7.6]	11.1 [10.9]	9.3 [9.3]	7.9 [7.8]
Acceleration 0-100 (xDrive) km/h	s	-	-	-	-	8.9 [9.1]	[7.6]

Fuel consumption <sup>6</sup>							
Urban (5-seater)	l/100 km	6.5-6.8	6.3-6.6 [6.5-6.7]	7.9-8.1 [7.3-7.5]	4.5-4.7 [4.5-4.7]	5.1-5.3 [4.9-5.1]	5.3-5.5 [5.0-5.2]
Urban (7-seater)	l/100 km	6.7-6.9	6.5-6.7 [6.6-6.8]	8.0-8.1 [7.3-7.5]	4.7-4.8 [4.7-4.9]	5.1-5.3 [4.9-5.1]	5.3-5.5 [5.1-5.3]
Urban (5-seater, xDrive)	l/100 km	-	-	-	-	6.0-6.2 [5.3-5.5]	[5.5-5.7]
Urban (7-seater, xDrive)	l/100 km	-	-	-	-	6.2-6.4 [5.5-5.7]	[5.5-5.7]
Extra-urban (5-seater)	l/100 km	4.6-4.9	4.4-4.7 [4.7-4.9]	5.2-5.4 [5.2-5.4]	3.6-3.8 [3.8-4.0]	3.9-4.1 [4.0-4.2]	4.1-4.3 [4.1-4.3]
Extra-urban (7-seater)	l/100 km	4.6-4.8	4.6-4.8 [4.8-4.9]	5.2-5.4 [5.2-5.4]	3.8-3.9 [3.8-4.0]	3.9-4.1 [4.1-4.2]	4.1-4.3 [4.2-4.4]
Extra-urban (5-seater, xDrive)	l/100 km	-	-	-	-	4.2-4.4 [4.4-4.6]	[4.5-4.7]
Extra-urban (7-seater, xDrive)	l/100 km	-	-	-	-	4.3-4.5 [4.5-4.7]	[4.5-4.7]
Combined (5-seater)	l/100 km	5.3-5.6	5.1-5.4 [5.3-5.5]	6.2-6.4 [5.9-6.2]	3.9-4.1 [4.0-4.3]	4.3-4.5 [4.3-4.5]	4.5-4.7 [4.4-4.6]
Combined (7-seater)	l/100 km	5.5-5.7	5.3-5.5 [5.5-5.6]	6.3-6.4 [6.0-6.2]	4.1-4.2 [4.1-4.3]	4.4-4.5 [4.4-4.5]	4.5-4.7 [4.5-4.7]
Combined (5-seater, xDrive)	l/100 km	-	-	-	-	4.9-5.1 [4.7-4.9]	[4.9-5.1]
Combined (7-seater, xDrive)	l/100 km	-	-	-	-	5.0-5.2 [4.9-5.1]	[4.9-5.1]

2 Series Gran Tourer		216i	218i	220i	216d	218d 218d xDrive	220d 220d xDrive
----------------------	--	------	------	------	------	---------------------	---------------------

Fuel consumption/emissions <sup>6</sup>							
CO <sub>2</sub> emissions (5-seater)	g/km	124-129	119-125 [124-129]	144-149 [138-143]	104-109 [106-112]	114-119 [114-119]	119-124 [117-122]
CO <sub>2</sub> emissions (7-seater)	g/km	128-132	123-127 [127-130]	145-149 [139-143]	108-111 [109-114]	115-119 [115-119]	119-124 [119-124]
CO <sub>2</sub> emissions (5-seater, xDrive)	g/km	-	-	-	-	128-133 [124-129]	[128-133]
CO <sub>2</sub> emissions (7-seater, xDrive)	g/km	-	-	-	-	132-136 [128-133]	[129-134]
Tank capacity approx.	l	51	51	51	51	51	51

Wheels/tyres							
Tyre dimensions		205/60 R16 V	205/60 R16 V	205/55 R17 W	205/60 R16 V	205/60 R16 V	205/55 R17 W
Wheel dimensions		7J x 16	7J x 16	7.5J x 17	7J x 16	7J x 16	7.5J x 17
Material		light alloy	light alloy	light alloy	light alloy	light alloy	light alloy

<sup>1</sup> The figure quoted includes a 90% full tank, 68 kg for the driver and 7 kg for luggage. Unladen weight applies to vehicles with standard equipment. Optional equipment will increase this figure.

<sup>2</sup> The actual overall trailer weight may not exceed the max. permitted trailer load, while taking into account the max. permitted tow bar download.

<sup>3</sup> In conjunction with the optional spare wheel, the luggage compartment volume is reduced by 40 litres.

<sup>4</sup> BMW recommends the use of RON 95 super unleaded petrol. Unleaded fuels RON 91 and higher with a maximum ethanol percentage of 10% may also be used. Output and fuel consumption figures apply to 98 RON fuel.

<sup>5</sup> All engines comply with the EU6 emissions standard. Fuel consumption is determined in accordance with the ECE driving cycle, which consists of approximately one-third urban traffic and two-thirds extra-urban driving (based on the distance covered). CO<sub>2</sub> emissions are measured in addition to fuel consumption.

<sup>6</sup> Optional equipment may increase fuel consumption and CO<sub>2</sub> emissions. Please consult your local BMW partner for more detailed information.

Values in [ ] refer to vehicles with Steptronic transmission.

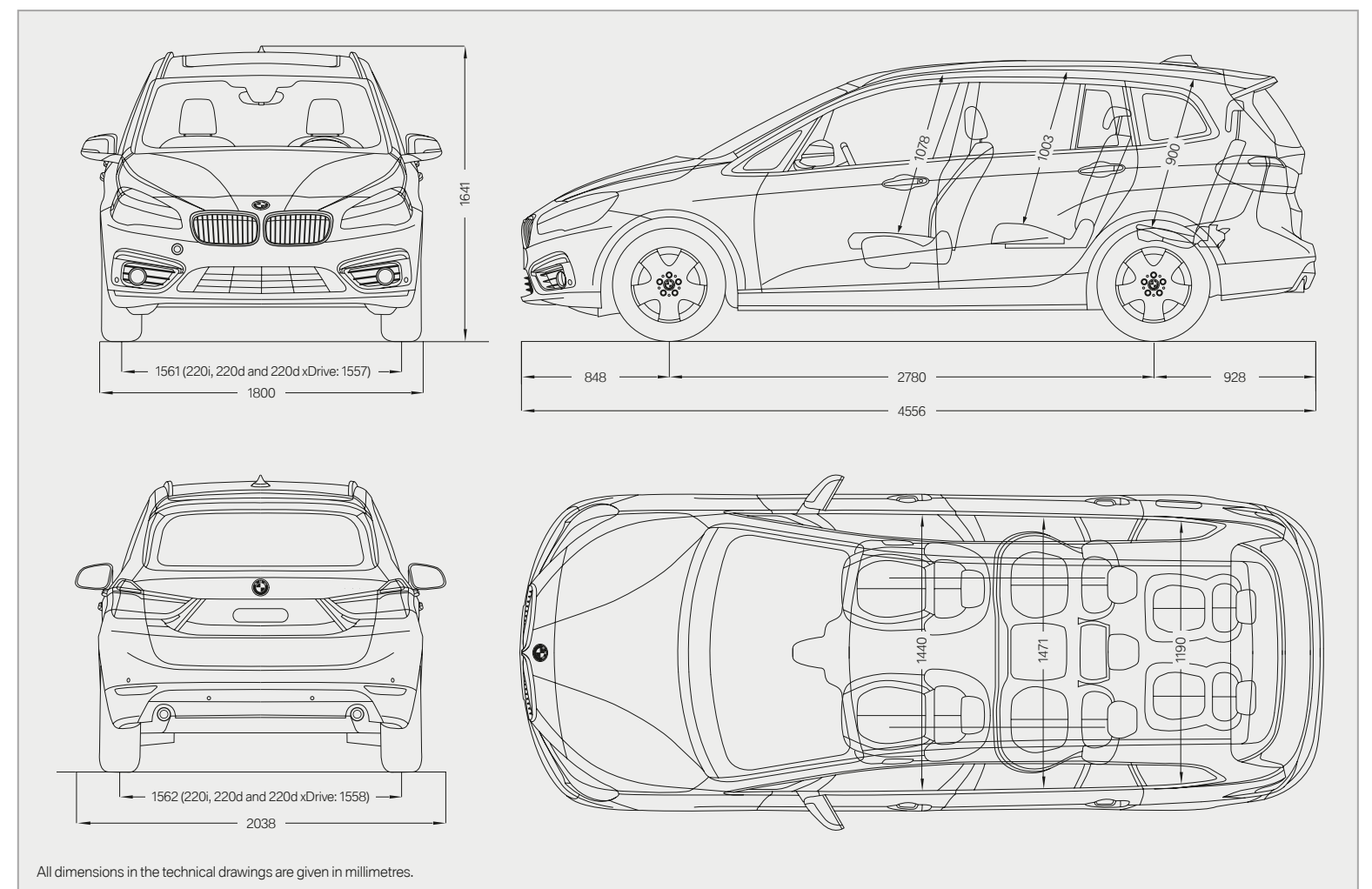

## WELL TAKEN CARE OF WITH BMW SERVICES:

When you buy a BMW, you can look forward to superb service and comprehensive customer care. For example, the **Condition Based Service** independently tracks both service fluid levels and the condition of parts subject to wear and then notifies you in the display when the vehicle requires servicing. So you only need to go to your BMW service partner when it's really necessary. When you do go, our

**qualified BMW service specialists** take care of your vehicle using the newest workshop technology and only **original BMW parts**. This service is available worldwide in more than 3,300 BMW service partner establishments in over 150 countries, to provide you with limitless driving pleasure.

### BMW SERVICE.



**BMW Service Packages\*:** Individual and stress-free, just for you. Individual, well-thought-out servicing solutions carefully tailored to you and your vehicle. With one-off, predictable costs, BMW Service Packages give you complete peace of mind, so you can enjoy owning a BMW to the very fullest. Whether it's fresh from the showroom or already well-travelled – there's a BMW Service Package for every phase of your vehicle's life. All bringing you maximum quality, expertise and value retention, always at reasonable, transparent rates. And always carefully tailored to you and your BMW. Find out just how stress-free truly individual service can be!

[www.bmw.com/serviceinclusive](http://www.bmw.com/serviceinclusive)



**BMW Mobile Service\*:** This service is there for you day and night. As soon as you call, we spring into action, and take care of everything that may need doing after an accident or breakdown, with specially trained technicians working – on site or via telephone – to get your car back on the road. We offer comprehensive, country-specific mobility packages for breakdowns, and insurance that covers you in the event of an accident or theft. So if anything untoward does happen, simply call up the BMW accident hotline and we'll go to work. We'll take care of calling the emergency services, a tow truck, a replacement car, notifying your insurance company and much more. For further information please visit [www.bmw.com](http://www.bmw.com)



**BMW TeleServices\*:** With Condition Based Service, you'll be automatically reminded of your next necessary service appointment on the vehicle screen. Provided you've consented, key vehicle data will be relayed to BMW automatically for analysis. Your assigned BMW service partner will access the information and contact you free of charge to make a service appointment as and when necessary. To access BMW Teleservices, the vehicle must be equipped with the optional Intelligent Emergency Call or ConnectedDrive Services. The service can be deactivated at any time you so desire, and you can change your service partner in the iDrive menu or ConnectedDrive portal. Find out more at [www.bmw.com/teleservices](http://www.bmw.com/teleservices)

### BMW FINANCIAL SERVICE.



**BMW Financial Services\*:** Mobility solutions to meet your needs. BMW Financial Services provides you with attractive leasing, finance and insurance options. To find out more, see the price list or go to [www.bmwfs.com](http://www.bmwfs.com). Your BMW partner will also be glad to draw up an individual offer for you in person.

### THE BMW EXPERIENCE.



**BMW TV\*:** [www.bmw.tv](http://www.bmw.tv) enables you to experience the BMW brand in all its diversity. Features, portraits and background reports provide you with information on automobiles, innovations, sports and lifestyle topics.



**BMW Driving Experience:** The better you control your BMW, the more enjoyment you will derive from driving it. Use our training courses to learn for yourself what it means to reach a car's physical limits on various types of surfaces, and what you have to do to control your vehicle even in extreme situations. For further information please visit [www.bmwdrivingexperience.com](http://www.bmwdrivingexperience.com)



**BMW Welt:** Picking up a car at BMW Welt has always ranked among the best moments for any driver. Turn this moment into one whole unforgettable day: experience the handover of your new BMW as just one part of a programme of activities perfectly tailored to your interests. At BMW Welt, the BMW Group plant, the BMW Museum, the BMW Group headquarters and the BMW Group Classic all combine to provide you with a great experience of an exciting history, a breathtaking present – and spectacular visions for the future. Find out more at [www.bmw-welt.com/en](http://www.bmw-welt.com/en)



**BMW Magazine:** In BMW Magazine, experience the newest BMW models in front of stunning backdrops. Discover new design trends, travel destinations and the richness of modern life. Encounter people with visionary ideas who are changing the world. Find out more at [www.bmw.com/magazine](http://www.bmw.com/magazine)

\* May not be available in all countries. Please consult your BMW partner.

## SHAPING THE FUTURE – RESPONSIBLY.

In 2015, the BMW Group was once more listed in the Dow Jones Sustainability Index as the most sustainable automotive company worldwide. This makes BMW Group the only company in the automotive industry to be listed without interruption since the index was established. The development of efficient vehicle concepts and environmentally friendly production processes, including recycling, is an integral part of our philosophy. BMW EfficientDynamics and electric vehicles have enabled us to cut CO<sub>2</sub> emissions from our European new-vehicle fleet by more than 40% since 1995. We have also reduced the amount of resources used in production, such as water and energy, by 34% between 2006 and 2015, with a reduction to 45% of previous levels aimed at for 2020. In terms of other resources (such as volatile organic compounds, process wastewater and waste) our 45% target was met in 2014, and we will continue to work on further improvement. Production at our engine plant in Steyr has been waste-water free since 2007. And of course, at the end of its service life, every one of our vehicles can be easily and economically recycled. To return your end-of-life vehicle, please contact your BMW partner. For more information on this issue please visit our website.

[www.bmw.com/EfficientDynamics](http://www.bmw.com/EfficientDynamics)  
[www.bmwgroup.com/responsibility](http://www.bmwgroup.com/responsibility)  
[www.bmw.com/recycling](http://www.bmw.com/recycling)

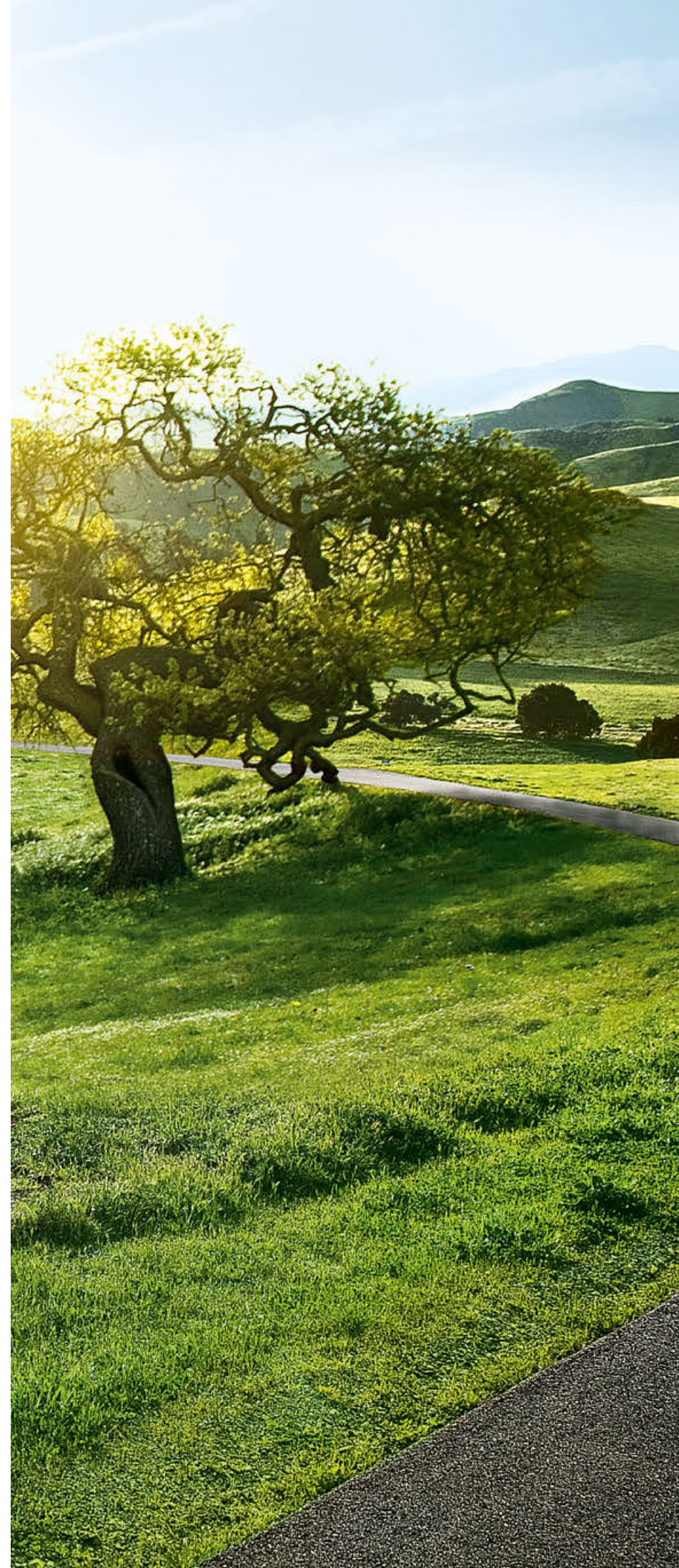

More about BMW



Sheer  
Driving Pleasure

[www.bmw.com](http://www.bmw.com)

The models illustrated in this brochure show the specifications of vehicles produced by BMW AG for the German market. In part, they include optional equipment and accessories not fitted as standard. According to the specific requirements of the markets of other European Union member states, alterations in models, standard and optional equipment, as described in this brochure, may occur. For more information about country-specific vehicle versions, please contact your local BMW partner. Subject to change in design and equipment.

© BMW AG, Munich/Germany. Not to be reproduced wholly or in part without written permission of BMW AG, Munich.

4 11 002 249 202 2016 BM. Printed in Germany 2016.

